



**OWNER'S MANUAL
USO E MANUTENZIONE
MANUAL DEL PROPIETARIO**

CBR1100XX



Honda CBR1100XX

OWNER'S MANUAL

USO E MANUTENZIONE

MANUAL DEL PROPIETARIO

IMPORTANT INFORMATION

- **OPERATOR AND PASSENGER**

This motorcycle is designed to carry the operator and one passenger. Never exceed the maximum weight capacity as shown on the accessories and loading label.

- **ON-ROAD USE**

This motorcycle is designed to be used only on the road.

- **READ THIS OWNER'S MANUAL CAREFULLY**

Pay special attention to the safety messages that appear throughout the manual. These messages are fully explained in the "A Few Words About Safety" section which appears before the Contents page.

This manual should be considered a permanent part of the motorcycle and should remain with the motorcycle when resold.

Honda CBR1100XX OWNER'S MANUAL

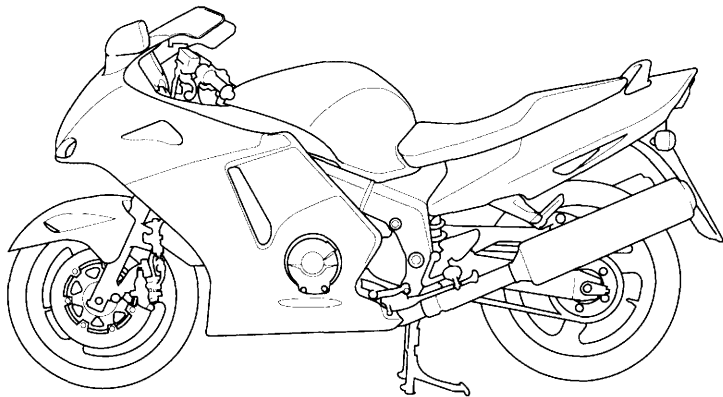

All information in this publication is based on the latest production information available at the time of approval for printing. Honda Motor Co.,Ltd. reserves the right to make changes at any time without notice and without incurring any obligation.

No part of this publication may be reproduced without written permission.

WELCOME

The motorcycle presents you a challenge to master the machine, a challenge to adventure. You ride through the wind, linked to the road by a vehicle that responds to your commands as no other does. Unlike an automobile, there is no metal cage around you. Like an airplane, a pre-ride inspection and regular maintenance are essential to your safety. Your reward is freedom.

To meet the challenges safely, and to enjoy the adventure fully, you should become thoroughly familiar with this owner's manual **BÉFORE YOU RIDE THE MOTORCYCLE**.

As you read this manual, you will find information that is preceded by a **NOTICE** symbol. This information is intended to help you avoid damage to your motorcycle, other property, or the environment.

When service is required, remember that your Honda dealer knows your motorcycle best. If you have the required mechanical "know-how" and tools, your dealer can supply you with an official Honda Service Manual to help you perform many maintenance and repair tasks.

Pleasant riding, and thank you for choosing a Honda !

- The following codes in this manual indicate each country.

E	UK	F	France
ED	European direct sales		Belgium
	Belgium	U	Australia New Zealand
	Denmark	BR	Brazil
	Spain	EK	Ireland
	Luxembourg	III E	(E Type III)
	Portugal	II F	(F Type II)
	Switzerland	II ED	(Europe Type II)
	Slovakia	IV EK	(EK Type II)
	Macedonia	II U	(U Type II)
	Ukraine		

- The specifications may vary with each locale.

A FEW WORDS ABOUT SAFETY

Your safety, and the safety of others, is very important. And operating this motorcycle safely is an important responsibility.

To help you make informed decisions about safety, we have provided operating procedures and other information on labels and in this manual. This information alerts you to potential hazards that could hurt you or others.

Of course, it is not practical or possible to warn you about all hazards associated with operating or maintaining a motorcycle. You must use your own good judgment.

You will find important safety information in a variety of forms, including:

- **Safety Labels** — on the motorcycle.
- **Safety Messages** — preceded by a safety alert symbol  and one of three signal words: **DANGER, WARNING, or CAUTION.**

These signal words mean:

▲ DANGER

You **WILL** be **KILLED** or **SERIOUSLY HURT** if you don't follow instructions.

▲ WARNING

You **CAN** be **KILLED** or **SERIOUSLY HURT** if you don't follow instructions.

▲ CAUTION

You **CAN** be **HURT** if you don't follow instructions.

- **Safety Headings** — such as Important Safety Reminders or Important Safety Precautions.
- **Safety Section** — such as Motorcycle Safety.
- **Instructions** — how to use this motorcycle correctly and safely.

This entire manual is filled with important safety information — please read it carefully.

OPERATION

page

1 MOTORCYCLE SAFETY

- 1 IMPORTANT SAFETY INFORMATION
- 2 PROTECTIVE APPAREL
- 4 LOAD LIMITS AND GUIDELINES

8 PARTS LOCATION

- 11 INSTRUMENTS AND INDICATORS

24 MAJOR COMPONENTS

(Information you need to operate this motorcycle)

- 24 SUSPENSION
- 26 BRAKES
- 29 CLUTCH
- 31 COOLANT
- 33 FUEL
- 36 ENGINE OIL
- 37 TUBELESS TYRES

page

43 ESSENTIAL INDIVIDUAL COMPONENTS

- 43 IGNITION SWITCH
- 44 KEYS
- 46 IMMOBILIZER SYSTEM (HISS)
< Except BR type >
- 49 RIGHT HANDLEBAR CONTROLS
- 51 LEFT HANDLEBAR CONTROLS

page

52 FEATURES

(Not required for operation)

52	STEERING LOCK
53	HELMET HOLDER
54	SEAT
55	DOCUMENT BAG
56	STORAGE COMPARTMENT FOR U-SHAPED ANTI-THEFT LOCK
57	REAR COWL
58	LOWER COWL
60	UPPER COWL COVER
61	WIND GUARD
62	INNER PANEL
63	HEADLIGHT AIM VERTICAL ADJUSTMENT

page

64 OPERATION

64	PRE-RIDE INSPECTION
66	STARTING THE ENGINE
69	RUNNING-IN
70	RIDING
72	BRAKING
74	PARKING
75	ANTI-THEFT TIPS

MAINTENANCE

page

76 MAINTENANCE

76	THE IMPORTANCE OF MAINTENANCE
77	MAINTENANCE SAFETY
78	SAFETY PRECAUTIONS
79	MAINTENANCE SCHEDULE
82	TOOL KIT
83	SERIAL NUMBERS
84	COLOUR LABEL
85	ENGINE OIL
91	SPARK PLUGS
96	THROTTLE OPERATION
97	IDLE SPEED
98	COOLANT
99	DRIVE CHAIN
105	DRIVE CHAIN SLIDER
106	FRONT AND REAR SUSPENSION INSPECTION
107	SIDE STAND
108	WHEEL REMOVAL
116	BRAKE PAD WEAR
118	BRAKE SYSTEM INSPECTION

page

119	BATTERY
121	FUSE REPLACEMENT
124	STOPLIGHT SWITCH ADJUSTMENT
125	BULB REPLACEMENT

131 CLEANING

136 STORAGE GUIDE

136	STORAGE
138	REMOVAL FROM STORAGE

139 SPECIFICATIONS

143 CATALYTIC CONVERTERS

< Except BR type >

144 NOISE CONTROL SYSTEM (AUSTRALIA ONLY)

MOTORCYCLE SAFETY

IMPORTANT SAFETY INFORMATION

Your motorcycle can provide many years of service and pleasure – if you take responsibility for your own safety and understand the challenges that you can meet on the road.

There is much that you can do to protect yourself when you ride. You'll find many helpful recommendations throughout this manual. Following are a few that we consider most important.

Always Wear a Helmet

It's a proven fact: helmets significantly reduce the number and severity of head injuries. So always wear an approved motorcycle helmet and make sure your passenger does the same. We also recommend that you wear eye protection, sturdy boots, gloves, and other protective gear (page 2).

Make Yourself Easy to See

Some drivers do not see motorcycles because they are not looking for them. To make yourself more visible, wear bright reflective clothing, position yourself so other drivers can see you, signal before turning or changing lanes, and use your horn when it will help others notice you.

Ride Within Your Limits

Pushing the limits is another major cause of motorcycle accidents. Never ride beyond your personal abilities or faster than conditions warrant. Remember that alcohol, drugs, fatigue and inattention can significantly reduce your ability to make good judgements and ride safely.

Don't Drink and Ride

Alcohol and riding don't mix. Even one drink can reduce your ability to respond to changing conditions, and your reaction time gets worse with every additional drink. So don't drink and ride, and don't let your friends drink and ride either.

Keep Your Bike in Safe Condition

For safe riding, it's important to inspect your motorcycle before every ride and perform all recommended maintenance. Never exceed load limits, and only use accessories that have been approved by Honda for this motorcycle. See page 4 for more details.

PROTECTIVE APPAREL

For your safety, we strongly recommend that you always wear an approved motorcycle helmet, eye protection, boots, gloves, long pants, and a long-sleeved shirt or jacket whenever you ride. Although complete protection is not possible, wearing proper gear can reduce the chance of injury when you ride.

Following are suggestions to help you choose proper gear.

WARNING

Not wearing a helmet increases the chance of serious injury or death in a crash.

Be sure you and your passenger always wear a helmet, eye protection and other protective apparel when you ride.

Helmets and Eye Protection

Your helmet is your most important piece of riding gear because it offers the best protection against head injuries. A helmet should fit your head comfortably and securely. A bright-coloured helmet can make you more noticeable in traffic, as can reflective strips.

An open-face helmet offers some protection, but a full-face helmet offers more. Always wear a face shield or goggles to protect your eyes and help your vision.

Additional Riding Gear

In addition to a helmet and eye protection, we also recommend:

- Sturdy boots with non-slip soles to help protect your feet and ankles.
- Leather gloves to keep your hands warm and help prevent blisters, cuts, burns and bruises.
- A motorcycle riding suit or jacket for comfort as well as protection. Bright-coloured and reflective clothing can help make you more noticeable in traffic. Be sure to avoid loose clothes that could get caught on any part of your motorcycle.

LOAD LIMITS AND GUIDELINES

Your motorcycle has been designed to carry you and one passenger. When you carry a passenger, you may feel some difference during acceleration and braking. But so long as you keep your motorcycle well-maintained, with good tyres and brakes, you can safely carry loads within the given limits and guidelines.

However, exceeding the weight limit or carrying an unbalanced load can seriously affect your motorcycle's handling, braking and stability. Non-Honda accessories, improper modifications, and poor maintenance can also reduce your safety margin.

The following pages give more specific information on loading, accessories and modifications.

Loading

How much weight you put on your motorcycle, and how you load it, are important to your safety. Anytime you ride with a passenger or cargo you should be aware of the following information.

WARNING

Overloading or improper loading can cause a crash and you can be seriously hurt or killed.

Follow all load limits and other loading guidelines in this manual.

Load Limits

Following are the load limits for your motorcycle:

Maximum weight capacity:

185 kg (411 lbs)

Includes the weight of the rider, passenger, all cargo and all accessories

Maximum cargo weight:

27 kg (60 lbs)

The weight of added accessories will reduce the maximum cargo weight you can carry.

Loading Guidelines

Your motorcycle is primarily intended for transporting you and a passenger. You may wish to secure a jacket or other small items to the seat when you are not riding with a passenger.

If you wish to carry more cargo, check with your Honda dealer for advice, and be sure to read the information regarding accessories on page 6 .

Improperly loading your motorcycle can affect its stability and handling. Even if your motorcycle is properly loaded, you should ride at reduced speeds and never exceed 130 km/h (80 mph) when carrying cargo.

Follow these guidelines whenever you carry a passenger or cargo:

- Check that both tyres are properly inflated.
- If you change your normal load, you may need to adjust the rear suspension (page 24).
- To prevent loose items from creating a hazard, make sure that all cargo is securely tied down before you ride away.
- Place cargo weight as close to the center of the motorcycle as possible.
- Balance cargo weight evenly on both sides.

Accessories and Modifications

Modifying your motorcycle or using non-Honda accessories can make your motorcycle unsafe. Before you consider making any modifications or adding an accessory, be sure to read the following information.

WARNING

Improper accessories or modifications can cause a crash in which you can be seriously hurt or killed.

Follow all instructions in this owner's manual regarding accessories and modifications.

Accessories

We strongly recommend that you use only genuine Honda accessories that have been specifically designed and tested for your motorcycle. Because Honda cannot test all other accessories, you must be personally responsible for proper selection, installation and use of non-Honda accessories. Check with your dealer for assistance and always follow these guidelines:

- Make sure the accessory does not obscure any lights, reduce ground clearance and banking angle, limit suspension travel or steering travel, alter your riding position or interfere with operating any controls.
- Be sure electrical equipment does not exceed the motorcycle's electrical system capacity (page 142). A blown fuse can cause a loss of lights or engine power.

- Do not pull a trailer or sidecar with your motorcycle. This motorcycle was not designed for these attachments, and their use can seriously impair your motorcycle's handling.

Modifications

We strongly advise you not to remove any original equipment or modify your motorcycle in any way that would change its design or operation. Such changes could seriously impair your motorcycle's handling, stability and braking, making it unsafe to ride.

Removing or modifying your lights, mufflers, emission control system or other equipment can also make your motorcycle illegal.

PARTS LOCATION

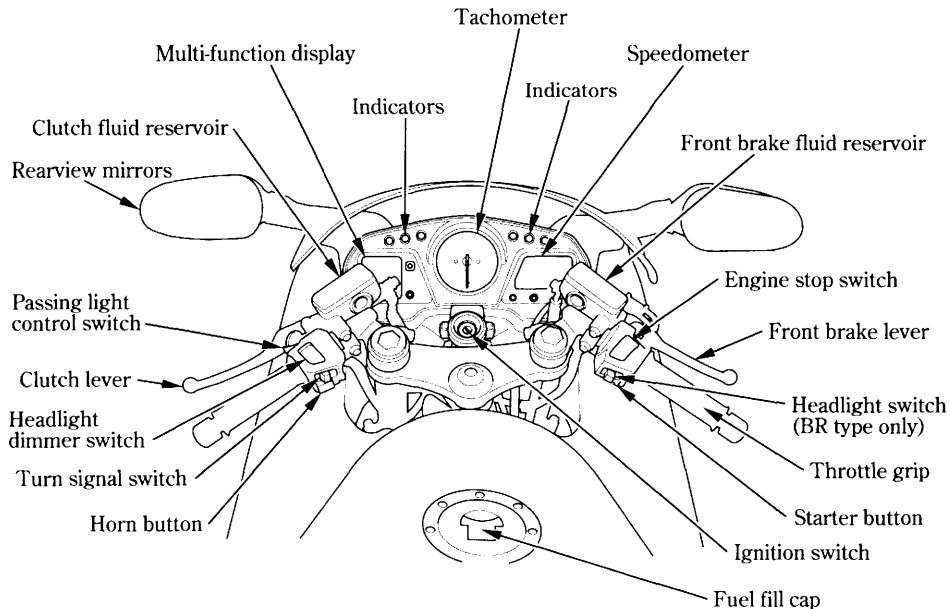

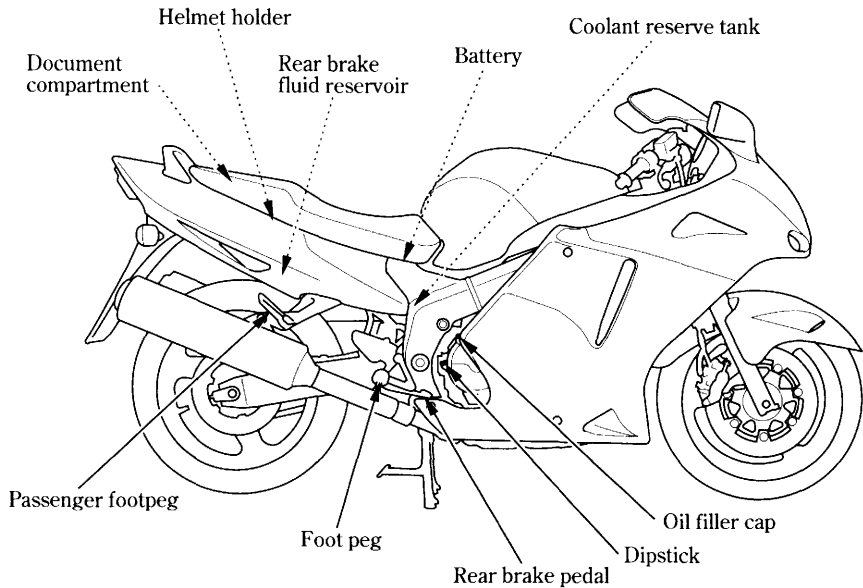

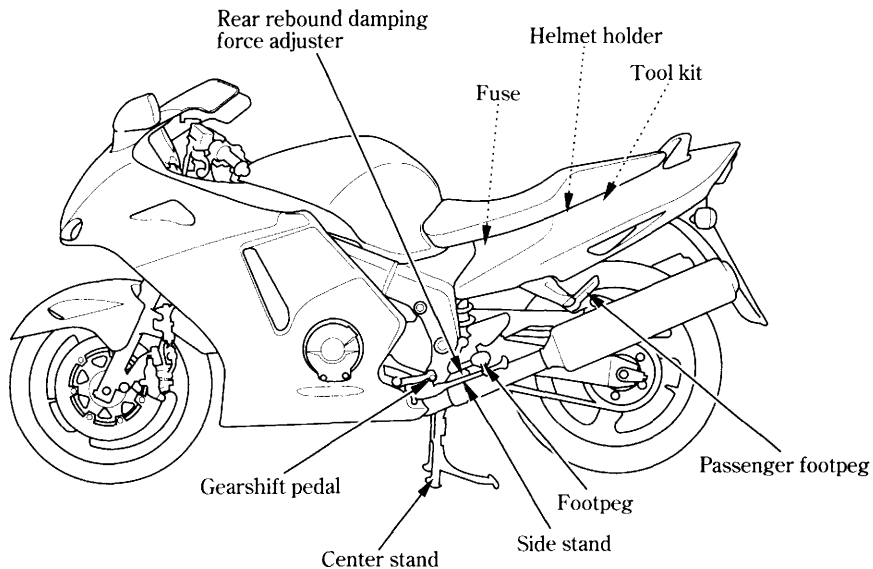

INSTRUMENTS AND INDICATORS

The indicators are contained in the instrument panel. Their functions are described in the tables on the following pages.

- (1) Neutral indicator
- (2) Low oil pressure indicator
- (3) Right turn signal indicator
- (4) Speedometer
- (5) HISS button
< Except BR type >
- (6) Immobilizer system (HISS) indicator
< Except BR type >
- (7) MODE button
- (8) SET button
- (9) Multi-function display
- (10) Left turn signal indicator
- (11) High beam indicator
- (12) PGM-FI malfunction indicator lamp
(MIL)
- (13) Tachometer
- (14) Tachometer red zone

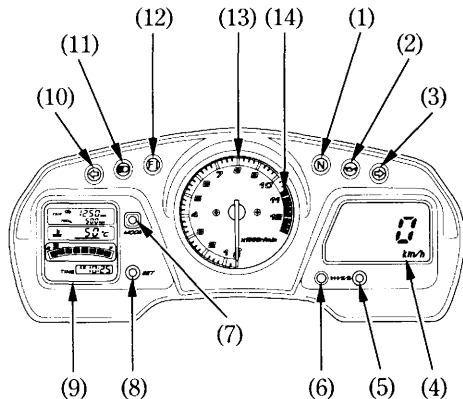

(Ref.No.) Description	Function
(1) Neutral indicator (green)	Lights when the transmission is in neutral. Should also light for a few seconds and then go off when the ignition switch is turned ON.
(2) Low oil pressure indicator (red)	<p>Lights when the engine oil pressure is below normal operating range. Should light when ignition switch is ON and engine is not running. Should go out when the engine starts, except for occasional flickering at or near idling speed when engine is warm.</p> <p>NOTICE</p> <p>Running the engine with insufficient oil pressure may cause serious engine damage.</p>
(3) Right turn signal indicator (green)	Flashes when the right turn signal operates. Should light for a few seconds and then go off when the ignition switch is turned ON.
(4) Speedometer	Shows riding speed (page 21).

(Ref.No.) Description	Function
(5) HISS button	<p>Except BR type: This button is used to flash the immobilizer system (HISS) indicator when the ignition switch is OFF (page 47).</p>
(6) Immobilizer system (HISS) indicator (red)	<p>Except BR type: This indicator lights for a few seconds when the ignition switch is turned ON and the engine stop switch is at \odot (RUN). It will then go off if the properly-coded key has been inserted. If an improperly-coded key has been inserted, the indicator will remain on and the engine will not start (page 46).</p>
(7) MODE button	<p>Select tripmeter A or B and resets the tripmeter to zero (0) (page 20). This button is also used to change unit of speedometer (page 21).</p>
(8) SET button	<p>This button is used to adjust the time (page 22). This button is also used to change unit of speedometer (page 21).</p>

(Ref.No.) Description	Function
(9) Multi-function display	The display includes the following functions; This display shows the initial display (page 17).
Coolant temperature meter	Shows coolant temperature (page 23).
Fuel gauge	Shows approximate fuel supply available (page 19).
Digital clock	Shows hour and minute (page 22).
Odometer	Shows accumulated mileage (page 20).
Tripmeter	Shows mileage per trip (page 20).

(Ref.No.) Description	Function
(10) Left turn signal indicator (green)	Flashes when the left turn signal operates. Should light for a few seconds and then go off when the ignition switch is turned ON.
(11) High beam indicator (blue)	Lights when the headlight is on high beam. Should also light for a few seconds and then go off when the ignition switch is turned ON.
(12) PGM-FI malfunction indicator lamp (MIL) (red)	Flashes when there is any abnormality in the PGM-FI (Programmed Fuel Injection) system. Should also light for a few seconds and then go off when the ignition switch is turned ON and engine stop switch is at  (RUN). If it comes on at any other time, reduce speed and take the motorcycle to your Honda dealer as soon as possible.

(Ref.No.) Description	Function
(13) Tachometer	Shows engine revolutions per minute.
(14) Tachometer red zone	<p>Never allow the tachometer needle to enter the red zone, even after the engine has been broken in.</p> <p>NOTICE</p> <p>Running the engine beyond recommended maximum engine speed (the beginning of the tachometer red zone) can damage the engine.</p>

Initial Display

When the ignition switch is turned ON, the multi-function display (1) and speedometer (2) will temporarily show all the modes and digital segments. Thereafter, the speedometer (2) will show from 290 km/h to 0 km/h (E type only: From 180 mph to 0 mph in mph) and the coolant temperature meter (3) will show from 132°C to 35°C.

In the view of that operation, you can make sure the liquid crystal display is functioning properly.

(Except digital clock)

The unit “mph” and “mile” will be displayed only for E type.

Digital clock (4) and tripmeter (5) will reset if the battery is disconnected.

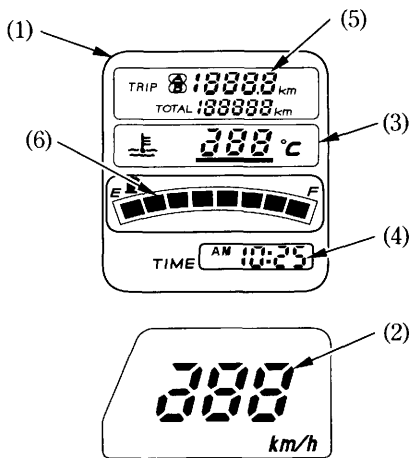

- | | |
|-------------------------------|----------------------|
| (1) Multi-function display | (4) Digital clock |
| (2) Speedometer | (5) Tripmeter |
| (3) Coolant temperature meter | (6) Fuel gauge meter |

Multi-function Display

Multi-function display (1) includes the following functions:

- Odometer
- Tripmeter
- Coolant temperature meter
- Fuel gauge
- Digital clock

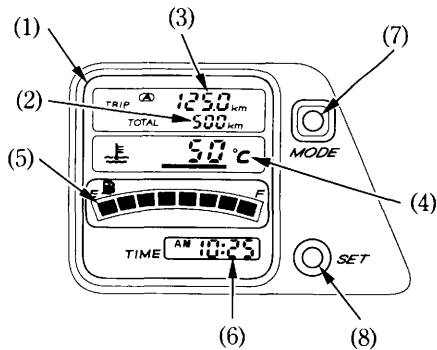

- (1) Multi-function display
- (2) Odometer
- (3) Tripmeter
- (4) Coolant temperature meter
- (5) Fuel gauge
- (6) Digital clock
- (7) MODE button
- (8) SET button

Fuel Gauge

The fuel gauge liquid crystal display (1) shows the approximate fuel supply available in a graduated display. When the segment F goes on, the fuel tank capacity including reserve is:

23.0 ℓ (6.08 US gal , 5.06 Imp gal)

When segment E (2) flashes, fuel will be low and you should refill the tank as soon as possible.

The amount of fuel left in the tank with the vehicle set upright is approximately:

3.0 ℓ (0.79 US gal , 0.66 Imp gal)

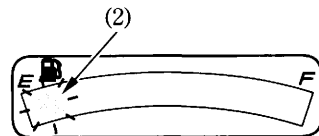
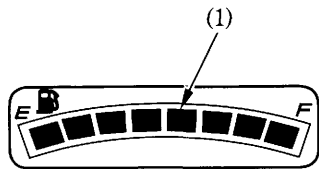

- (1) Fuel gauge display
- (2) Segment E

Odometer

Shows accumulated mileage.

Tripmeter

Shows mileage per trip.

There are two tripmeters, tripmeter A (3) and tripmeter B (4). Switch between the A and B displays by pressing the MODE button (5) repeatedly.

To reset the tripmeter, push and hold the MODE button with the display in the tripmeter A or tripmeter B mode.

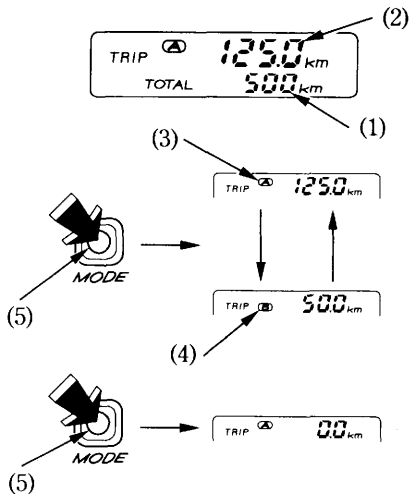

- (1) Odometer
- (2) Tripmeter
- (3) Tripmeter A

- (4) Tripmeter B
- (5) MODE button

Speedometer

Shows riding speed.

Speed Unit Change (E type only)

The speedometer displays both “km/h” and “mph”.

Push and hold both the MODE (2) and SET (3) button to select “km/h” or “mph”. This function does not operate while set the clock in the adjust mode.

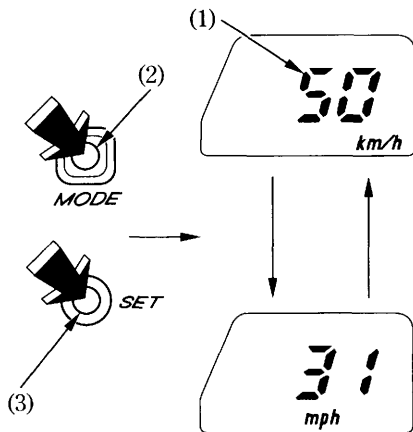

- (1) Speedometer
- (2) MODE button

- (3) SET button

Digital Clock

Shows hour and minute. To adjust the time, proceed as follows:

1. Turn the ignition switch ON.
2. Press and hold the SET button (2) for more than 2 seconds. The clock will be set in the adjust mode with the display flashing.

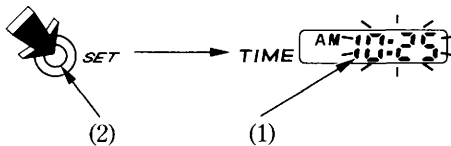

- (1) Digital clock
(2) SET button

3. Push the button until the desired time is displayed.
 - The time is advanced by one minute, each time the button is pushed.
 - The time is advanced by ten minutes, when the button is pushed and held.
4. Push the SET button after five seconds pass with not doing anything to enter the time.
When the ignition switch is turned OFF while set the clock in the adjust mode, the time will be fixed as just before the ignition OFF.

Coolant Temperature Meter

The coolant temperature meter (1) shows coolant temperature digitally.

Temperature Display

Below 34°C	“— —” is displayed.
Between 35°C and 132°C	Actual coolant temperature is indicated.
Above 132°C	The display will remain “132°C”.

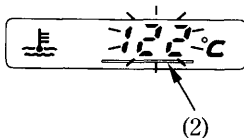
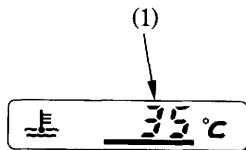

- (1) Coolant temperature meter
- (2) Red line

Overheating Message

When the coolant temperature reaches 122°C, the display begins to flash and “red line” (2) appears on the display.

If this occurs, stop the engine and check the reserve tank coolant level. Read pages 31 – 32 and do not ride the motorcycle until the problem has been corrected.

NOTICE

Exceeding maximum running temperature may cause serious engine damage.

MAJOR COMPONENTS

(Information you need to operate this motorcycle)

SUSPENSION

Rear Suspension

The rear suspension can provide the desired ride under various rider/passenger weight and riding conditions through adjustments of the rebound damping adjuster.

Rebound Damping:

The damping force adjuster (1) is located behind the left step holder.

To reduce (SOFT) :

Turn the adjuster counterclockwise toward SOFT for a light load and smooth road condition.

To increase (HARD) :

Turn the adjuster clockwise toward HARD for a firmer ride and rough road condition.

To adjust the adjuster to the standard position, proceed as follows :

1. Turn the damping adjuster (1) clockwise until it will no longer turn (lightly seats). This is the full hard setting.
2. The adjuster is set in the standard position when the adjuster is turned counterclockwise approximately 1 turn so that its punch mark (2) aligns with the reference punch mark (3).

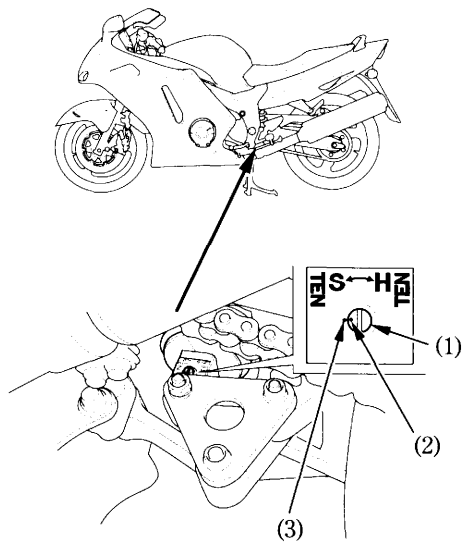

- (1) Damping adjuster
- (2) Punch mark
- (3) Reference punch mark

Do not touch the exhaust pipe when adjusting the rebound damping adjuster.

The rear shock absorber assembly includes a damper unit that contains high pressure nitrogen gas. Do not attempt to disassemble or service the damper; it cannot be rebuilt and must be replaced when worn out. Disposal should only be done by your Honda dealer. The instructions found in this owner's manual are limited to adjustment of the shock assembly only.

BRAKES

Both the front and rear brakes are the hydraulic disc types.

As the brake pads wear, the brake fluid level drops.

There are no adjustments to perform, but fluid level and pads wear must be inspected periodically. The system must be inspected frequently to ensure there are no fluid leaks. If the control lever or pedal free travel becomes excessive and the brake pads are not worn beyond the recommended limit (page 116), there is probably air in the brake system and it must be bled. See your Honda dealer for this service.

Front Brake Fluid Level:

With the motorcycle in an upright position, check the fluid level. It should be above the LOWER level mark (1). If the level is at or below the LOWER level mark (1), check the brake pads for wear (page 116).

Worn pads should be replaced. If the pads are not worn, have your brake system inspected for leaks.

The recommended brake fluid is Honda DOT 4 brake fluid from a sealed container, or an equivalent.

Front

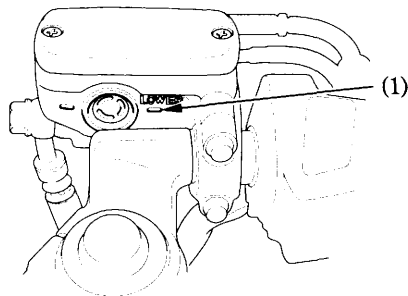

(1) LOWER level mark

Front Brake Lever:

The distance between the tip of the brake lever (1) and the grip can be adjusted by turning the adjuster (2) while pushing the lever forward.

Align the arrow (3) on the brake lever with the index mark (4) on the adjuster.

Apply the brake several times and check for free wheel rotation after the brake lever is released.

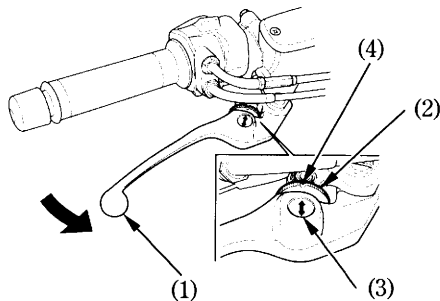

(1) Brake lever

(2) Adjuster

(3) Arrow

(4) Index mark

Other Checks:

Make sure there are no fluid leaks. Check for deterioration or cracks in the hoses and fittings.

Rear Brake Fluid Level:

Check the brake fluid level from the inspection window (1) of the rear cowl with the motorcycle in an upright position.

It should be between the UPPER (2) and LOWER (3) level marks. If the level is at or below the LOWER level mark, check the brake pads for wear (page 116).

Worn pads should be replaced. If the pads are not worn, have your brake system inspected for leaks.

The recommended brake fluid is Honda DOT 4 brake fluid from a sealed container, or an equivalent.

Other Checks:

Make sure there are no fluid leaks. Check for deterioration or cracks in the hoses and fittings.

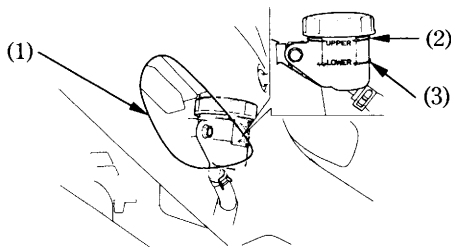

- (1) Inspection window
- (2) UPPER level mark
- (3) LOWER level mark

CLUTCH

This motorcycle has a hydraulically actuated clutch. There are no adjustments to perform, but the clutch system must be inspected periodically for fluid level and leakage.

If the control lever freeplay becomes excessive and the motorcycle creeps or stalls when shifted into gear, or if the clutch slips, causing acceleration to lag behind engine speed, there is probably air in the clutch system and it must be bled out. See your Honda dealer for this service.

Fluid Level:

Check that the fluid level is above the LOWER level mark (1) with the motorcycle in an upright position. If the fluid level is near the lower level line, it indicates fluid leakage. See your Honda dealer.

Other Checks:

Make sure there are no fluid leaks. Check for deterioration or cracks in the hoses and fittings.

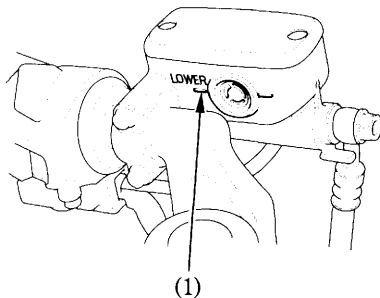

(1) LOWER level mark

Clutch Lever:

The distance between the tip of the clutch lever (1) and the grip can be adjusted by turning the adjuster (2) while pushing the lever forward.

Align the arrow (3) on the clutch lever with the index mark (4) on the adjuster.

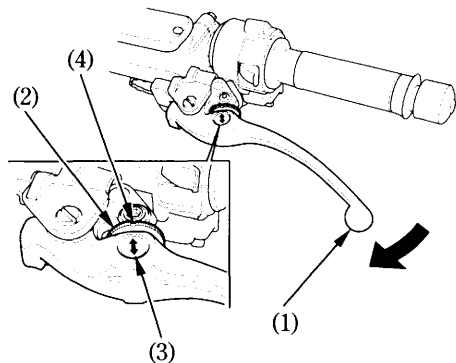

(1) Clutch lever
(2) Adjuster

(3) Arrow
(4) Index mark

COOLANT

Coolant Recommendation

The owner must properly maintain the coolant to prevent freezing, overheating, and corrosion. Use only high quality ethylene glycol antifreeze containing corrosion protection inhibitors specifically recommended for use in aluminum engines. (SEE ANTIFREEZE CONTAINER LABEL).

Use only low-mineral drinking water or distilled water as a part of the antifreeze solution. Water that is high in mineral content or salt may be harmful to the aluminum engine.

Using coolant with silicate inhibitors may cause premature wear of water pump seals or blockage of radiator passages.

Using tap water may cause engine damage.

The factory provides a 50/50 solution of antifreeze and distilled water in this motorcycle. This coolant solution is recommended for most operating temperatures and provides good corrosion protection. A higher concentration of antifreeze decreases the cooling system performance and is recommended only when additional protection against freezing is needed. A concentration of less than 40/60 (40% antifreeze) will not provide proper corrosion protection. During freezing temperatures, check the cooling system frequently and add higher concentrations of antifreeze (up to a maximum of 60% antifreeze) if required.

Inspection

The reserve tank is behind the frame.

Check the coolant level in the reserve tank (1) while the engine is at the normal operating temperature with the motorcycle in an upright position. If the coolant level is below the LOWER level mark (3), remove the seat (page 54) and reserve tank cap (4) and add coolant mixture until it reaches the UPPER level mark (2). Always add coolant to the reserve tank. Do not attempt to add coolant by removing the radiator cap.

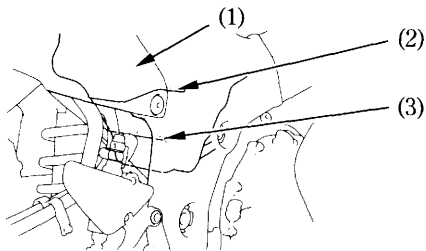

(1) Reserve tank

(3) LOWER level mark

(2) UPPER level mark

32

If the reserve tank is empty, or if coolant loss is excessive, check for leaks and see your Honda dealer for repair.

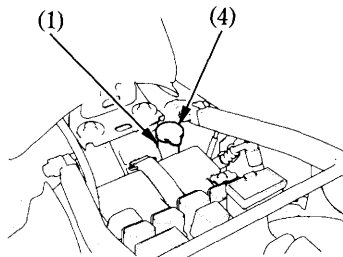

(1) Reserve tank

(4) Reserve tank cap

FUEL

Fuel Tank

The fuel tank capacity including the reserve supply is:

23.0 l (6.08 US gal , 5.06 Imp gal)

To open the fuel fill cap (1), insert the ignition key (2) and turn it clockwise. The fuel fill cap is hinged and will lift up.

Do not overfill the tank. There should be no fuel in the filler neck (3).

After refueling, to close the fuel fill cap, push the fuel fill cap into the filler neck until it snaps closed and locks. Remove the key.

⚠ WARNING

Petrol is highly flammable and explosive. You can be burned or seriously injured when handling fuel.

- Stop the engine and keep heat, sparks, and flame away.
- Refuel only outdoors.
- Wipe up spills immediately.

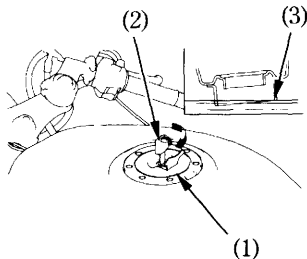

- (1) Fuel fill cap
(2) Ignition key

(3) Filler neck

Except BR type:

Use unleaded petrol with a research octane number of 91 or higher.

The use of leaded petrol will cause premature damage to the catalytic converters.

For BR type:

Use unleaded petrol with a research octane number of 91 or higher.

NOTICE

If “spark knock” or “pinking” occurs at a steady engine speed under normal load, change brands of petrol. If spark knock or pinking persists, consult your Honda dealer. Failure to do so is considered misuse, and damage caused by misuse is not covered by Honda’s Limited Warranty.

Petrol Containing Alcohol

If you decide to use a petrol containing alcohol (gasohol), be sure it's octane rating is at least as high as that recommended by Honda. There are two types of "gasohol": one containing ethanol, and the other containing methanol. Do not use petrol that contains more than 10 % ethanol. Do not use petrol containing methanol (methyl or wood alcohol) that does not also contain cosolvents and corrosion inhibitors for methanol. Never use petrol containing more than 5 % methanol, even if it has cosolvents and corrosion inhibitors.

Fuel system damage or engine performance problems resulting from the use of fuels that contain alcohol is not covered under the warranty. Honda cannot endorse the use of fuels containing methanol since evidence of their suitability is as yet incomplete.

Before buying fuel from an unfamiliar station, try to find out if the fuel contains alcohol. If it does, confirm the type and percentage of alcohol used. If you notice any undesirable operating symptoms while using a petrol that contains alcohol, or one that you think contains alcohol, switch to a petrol that you know does not contain alcohol.

ENGINE OIL

Engine Oil Level Check

Check the engine oil level each day before riding the motorcycle.

The level must be maintained between the upper (1) and lower (2) level marks on the dipstick (3).

1. Start the engine and let it idle for 3–5 minutes. Make sure the red low oil pressure indicator goes off. If the light remains on, stop the engine immediately.
2. Stop the engine and put the motorcycle on its center stand on level ground.
3. After 2–3 minutes, remove the dipstick, wipe it clean, and reinsert the dipstick without screwing it in. Remove the dipstick. The oil level should be between the upper and lower marks on the dipstick.
4. If required, remove the oil filler cap (4) and add the specified oil (page 85) up to the upper level mark. Do not overfill.
5. Reinstall the dipstick and oil filler cap. Check for oil leaks.

NOTICE

Running the engine with insufficient oil pressure may cause serious engine damage.

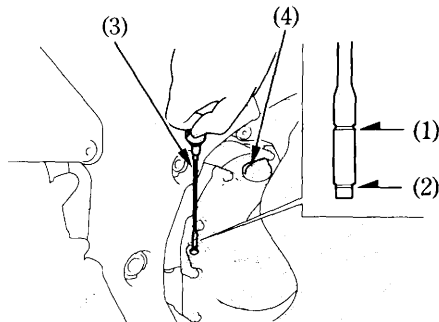

- | | |
|----------------------|--------------------|
| (1) Upper level mark | (3) Dipstick |
| (2) Lower level mark | (4) Oil filler cap |

TUBELESS TYRES

To safely operate your motorcycle, your tyres must be the proper type and size, in good condition with adequate tread, and correctly inflated for the load you are carrying. The following pages give more detailed information on how and when to check your air pressure, how to inspect your tyres for damage, and what to do when your tyres need to be repaired or replaced.

WARNING

Using tyres that are excessively worn or improperly inflated can cause a crash in which you can be seriously hurt or killed.

Follow all instructions in this owner's manual regarding tyre inflation and maintenance.

Air Pressure

Keeping your tyres properly inflated provides the best combination of handling, tread life and riding comfort. Generally, underinflated tyres wear unevenly, adversely affect handling, and are more likely to fail from being overheated.

Overinflated tyres make your motorcycle ride more harshly, are more prone to damage from road hazards, and wear unevenly.

We recommend that you visually check your tyres before every ride and use a gauge to measure air pressure at least once a month or any time you think the tyres might be low.

Tubeless tyres have some self-sealing ability if they are punctured. However, because leakage is often very slow, you should look closely for punctures whenever a tyre is not fully inflated.

Always check air pressure when your tyres are “cold” – when the motorcycle has been parked for at least three hours. If you check air pressure when your tyres are “warm” – when the motorcycle has been ridden for even a few miles – the readings will be higher than if the tyres were “cold”. This is normal, so do not let air out of the tyres to match the recommended cold air pressures given below. If you do, the tyres will be underinflated.

The recommended “cold” tyre pressures are:

Front	290 kPa (2.90 kgf/cm ² , 42 psi)
Rear	290 kPa (2.90 kgf/cm ² , 42 psi)

Inspection

Whenever you check the tyre pressures, you should also examine the tyre treads and sidewalls for wear, damage, and foreign objects:

Look for:

- Bumps or bulges in the side of the tyre or the tread. Replace the tyre if you find any bumps or bulges.
- Cuts, splits or cracks in the tyre. Replace the tyre if you can see fabric or cord.
- Excessive tread wear.

Also, if you hit a pothole or hard object, pull to the side of the road as soon as you safely can and carefully inspect the tyres for damage.

Tread Wear

Replace tyres before tread depth at the center of the tyre reaches the following limit:

Minimum tread depth	
Front:	1.5 mm (0.06 in)
Rear:	2.0 mm (0.08 in)

< For Germany >

German law prohibits use of tyres whose tread depth is less than 1.6 mm.

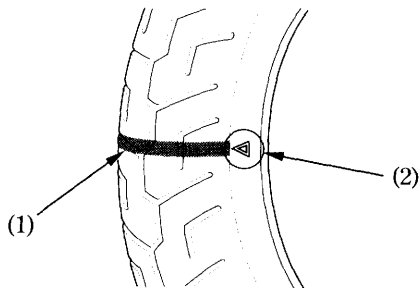

- (1) Wear indicator
- (2) Wear indicator location mark

Tyre Repair

If a tyre is punctured or damaged, you should replace it, not repair it. As discussed below, a tyre that is repaired, either temporarily or permanently, will have lower speed and performance limits than a new tyre.

A temporary repair, such as an external tubeless tyre plug, may not be safe for normal speeds and riding conditions. If a temporary or emergency repair is made to a tyre, you should ride slowly and cautiously to a dealer and have the tyre replaced. If possible, you should not carry a passenger or cargo until a new tyre is installed.

Even if a tyre is professionally repaired with a permanent internal patch plug, it will not be as good as a new tyre. You should not exceed 80 km/h (50 mph) for the first 24 hours, or 130 km/h (80 mph) at any time thereafter. In addition, you may not be able to safely carry as much weight as with a new tyre. Therefore, we strongly recommend that you replace a damaged tyre. If you choose to have a tyre repaired, be sure the wheel is balanced before you ride.

Tyre Replacement

The tyres that came on your motorcycle were designed to match the performance capabilities of your motorcycle and provide the best combination of handling, braking, durability and comfort.

WARNING

Installing improper tyres on your motorcycle can affect handling and stability. This can cause a crash in which you can be seriously hurt or killed.

Always use the size and type of tyres recommended in this owner's manual.

The recommended tyres for your motorcycle are:

Front: 120/70 ZR17 M/C (58W)
BRIDGESTONE...Except EK type
BT57F RADIAL G
DUNLOP
D205F J

Rear: 180/55 ZR17 M/C (73W)
BRIDGESTONE...Except EK type
BT57R RADIAL G
DUNLOP
D205 G

Whenever you replace a tyre, use one that is equivalent to the original and be sure the wheel is balanced after the new tyre is installed.

Important Safety Reminders

- Do not install a tube inside a tubeless tyre on this motorcycle. Excessive heat build-up can cause the tube to burst.
- Use only tubeless tyres on this motorcycle. The rims are designed for tubeless tyres, and during hard acceleration or braking, a tube-type tyre could slip on the rim and cause the tyre to rapidly deflate.

ESSENTIAL INDIVIDUAL COMPONENTS

IGNITION SWITCH

The ignition switch (1) is below the indicator panel.

< Except BR type >

The headlight and taillights will come on whenever you turn the ignition switch ON. If your motorcycle is stopped with the ignition switch ON and the engine is not running, the headlight and taillights will still be on, resulting in battery discharge.

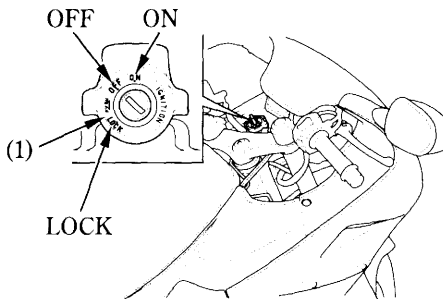

(1) Ignition switch

Key Position	Function	Key Removal
LOCK (steering lock)	Steering is locked. Engine and lights cannot be operated.	Key can be removed
OFF	Engine and lights cannot be operated.	Key can be removed
ON	Engine and lights can be operated.	Key cannot be removed

KEYS

This motorcycle has two keys and a key number plate.

〈Except BR type〉

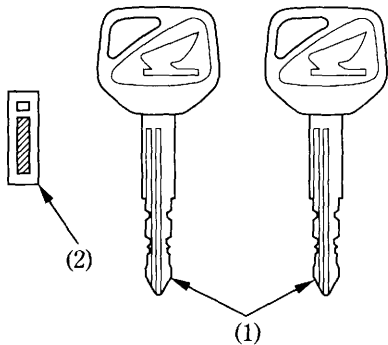

(1) Keys

(2) Key number plate

〈For BR type〉

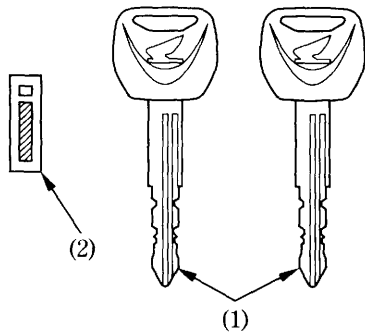

You will need the key number if you ever have to replace a key. Store the plate in a safe place.

< Except BR type >

To reproduce keys, bring all keys, key number plate and motorcycle to your Honda dealer.

Up to four keys can be registered with the immobilizer system (HISS), including the ones in hand.

< Except BR type >

If all keys are lost, the PGM-FI unit/ignition control module must be replaced. To avoid this possibility we recommend that if only one key is left, you immediately have it reproduced to ensure that a back-up is available.

These keys contain electronic circuits that are activated by the immobilizer system (HISS). They will not work to start the engine if the circuits are damaged.

- Do not grind, drill or in any way alter the original shape of the keys.
- Do not drop the keys or set heavy objects on them.
- Keep the keys away from magnetic objects.

IMMOBILIZER SYSTEM (HISS)

〈 **Except BR type** 〉

HISS is the abbreviation of Honda Ignition Security System.

The immobilizer system (HISS) protects your motorcycle from theft. A properly-coded key must be used in the ignition switch for the engine to start. If an improperly-coded key (or other device) is used the engine's starting circuit is disabled.

When the ignition switch is turned ON and the engine stop switch is at " ○ " (RUN), the immobilizer system (HISS) indicator lights for a few seconds, then goes off. If the indicator remains on, it means the system does not recognize the coding of the key. Turn the ignition switch to OFF, remove the key, reinsert and turn the switch ON again.

The immobilizer system (HISS) indicator continues to flash every 2 seconds during 24 hours when the ignition switch is OFF. After this period, the indicator automatically switches off.

To operate this function, proceed as follows:

1. Turn the ignition switch ON.
2. Push and hold the HISS button (2).
The immobilizer system (HISS) indicator (1) instantly flash, the function is enabled.
3. Turn the ignition switch OFF and the key is pulled out, then the indicator starts to flash.

Whenever the ignition switch is turned ON, the light operation is canceled.

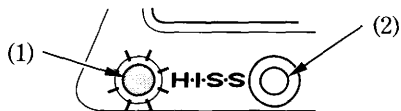

- (1) Immobilizer system (HISS) indicator
- (2) HISS button

If the system repeatedly does not recognize the coding of your key, contact your Honda dealer.

- The system may not recognize the key's coding if any other immobilizer key is near the ignition switch. To make sure the system recognizes the key code, keep each immobilizer key on a separate ring.
- Do not attempt to alter the immobilizer system (HISS) or add other devices to it. Electrical problems could result, making it impossible to start your motorcycle.
- If all keys are lost, the PGM-FI unit/ignition control module must be replaced.

EC Directives

This immobilizer system complies with the R & TTE (Radio equipment and telecommunications terminal equipment and the mutual recognition of their conformity) Directive.



CE 0891 !

The declaration of conformity to R & TTE Directive is provided to the owner at the time of purchase. The declaration of conformity should be kept at a safe place. When the declaration of conformity is lost or is not provided, contact your Honda dealer.

RIGHT HANDLEBAR CONTROLS

〈Except BR type〉

Engine Stop Switch

The engine stop switch (1) is next to the throttle grip. When the switch is in the  (RUN) position, the engine will operate. When the switch is in the  (OFF) position, the engine will not operate. This switch is intended primarily as a safety or emergency switch and should normally remain in the  (RUN) position.

If your motorcycle is stopped with the ignition switch ON and the engine stop switch  (OFF), the headlight and taillights will still be on, resulting in battery discharge.

Starter Button

The starter button (2) is below the engine stop switch (1).

The starter button is used for starting the engine. Pushing the button in starts the engine. See Starting Procedure, page 67.

When the starter button is pushed, the starter motor will crank the engine; the headlight will automatically go out, but the taillights will stay on.

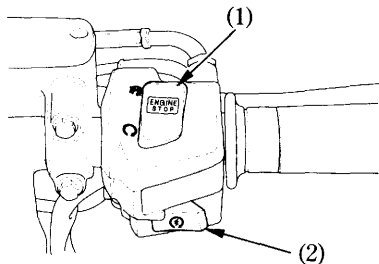



- (1) Engine stop switch
- (2) Starter button



RIGHT HANDLEBAR CONTROLS

〈BR type only〉

Engine Stop Switch

The engine stop switch (1) is next to the throttle grip. When the switch is in the  (RUN) position, the engine will operate. When the switch is in the  (OFF) position, the engine will not operate. This switch is intended primarily as a safety or emergency switch and should normally remain in the  (RUN) position.

Headlight Switch

The headlight switch (2) has three positions; ,  and OFF marked by a dot to the right of .

 : Headlight, taillight, position light and meter lights on.

 : Position light, taillight and meter lights on.

OFF (dot): Headlight, taillight, position light and meter lights off.

Starter Button

The starter button (3) is below the headlight switch (2).

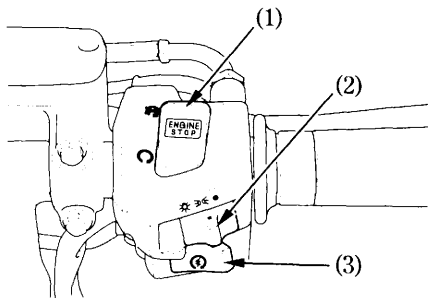

When the starter button is pressed, the starter motor cranks the engine. If the engine stop switch is in the  (OFF) position, the starter motor will not operate. See page 67 for the starting procedure.



- (1) Engine stop switch
- (2) Headlight switch
- (3) Starter button

LEFT HANDLEBAR CONTROLS



Headlight Dimmer Switch (1)

Push the dimmer switch to  (HI) to select high beam or to  (LO) to select low beam.

Passing Light Control Switch (2)

When this switch is pressed, the headlight flashes on to signal approaching cars or when passing.

Turn Signal Switch (3)

Move to  (L) to signal a left turn,  (R) to signal a right turn. Press to turn signal off.

Horn Button (4)

Press the button to sound the horn.

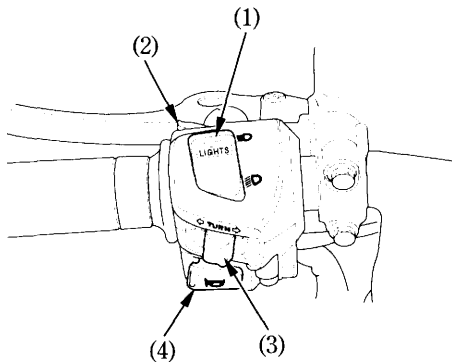

- (1) Headlight dimmer switch
- (2) Passing light control switch
- (3) Turn signal switch
- (4) Horn button

FEATURES

(Not required for operation)

STEERING LOCK

To lock the steering, turn the handlebars all the way to the left or right, turn the key (1) to LOCK while pushing in. Remove the key. To unlock the steering, turn the key to OFF while pushing in.

Do not turn the key to LOCK while riding the motorcycle; loss of vehicle control will result.

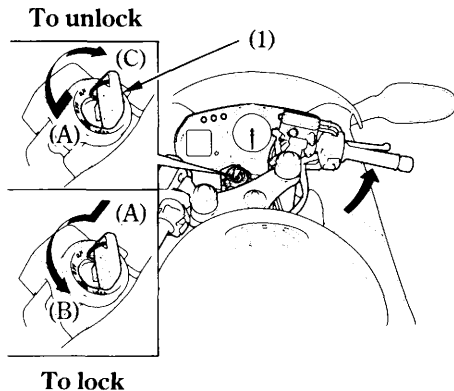

(1) Ignition key

- (A) Push in
- (B) Turn to LOCK
- (C) Turn to OFF

HELMET HOLDER

The helmet holders are located below the seat.

Remove the seat (page 54).

Hang the helmets on the holder hooks (1).

Install the seat and lock it securely.

⚠ WARNING

Riding with a helmet attached to the holder can interfere with the rear wheel or suspension and could cause a crash in which you can be seriously hurt or killed.

Use the helmet holder only while parked. Do not ride with a helmet secured by the holder.

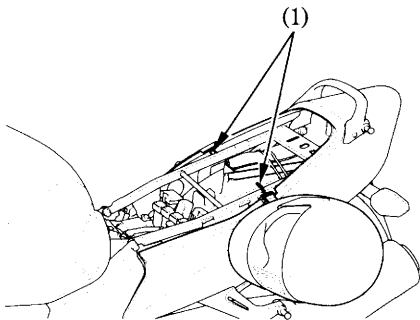

(1) Holder hooks

SEAT

To remove the seat (1), insert the ignition key (2) into the seat lock (3) and turn it clockwise. Pull the seat back and up.

To install the seat, insert the front prong (4) into the fuel tank stay (5) and the rear prongs (6) into the rear stay (7) on the frame and then push down on the rear of the seat.

Be sure the seat is locked securely in position after installation.

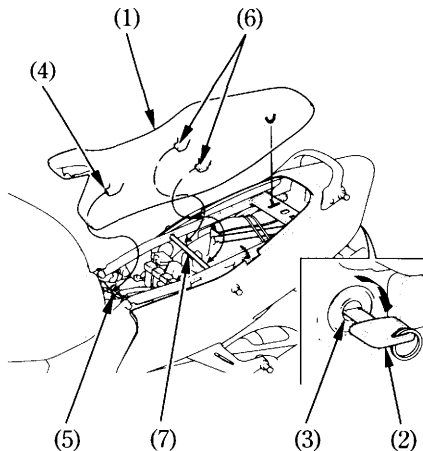

- | | |
|------------------|--------------------|
| (1) Seat | (5) Fuel tank stay |
| (2) Ignition key | (6) Rear prongs |
| (3) Seat lock | (7) Rear stay |
| (4) Front prong | |

DOCUMENT BAG

The document bag (1) is in the document compartment (2) on the reverse side of the seat (3).

This owner's manual and other documents should be stored in the document bag. When washing your motorcycle, be careful not to flood this area with water.

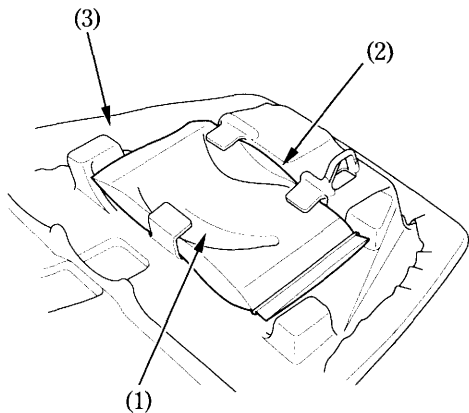

(1) Document bag

(3) Seat

(2) Document compartment

STORAGE COMPARTMENT FOR U-SHAPED ANTI-THEFT LOCK

The rear fender has a storage compartment to store a U-shaped anti-theft lock under the seat. After storing, be sure to fasten the lock with the rubber band (1) securely.

Some U-shaped locks may not be stored in the compartment due to their size or design.

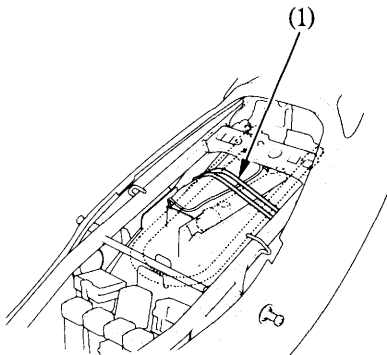

(1) Rubber band

REAR COWL

Removal:

1. Remove the seat (page 54).
2. Remove the caps (1), bolts (2) and washers (3).
3. Remove the rear grab rail (4).
4. Remove the bolts (5) and washers (6).
5. Carefully pry up on the front prongs (7) of the rear cowl (8) and remove the rear cowl by sliding it toward the rear.

Installation:

- Installation can be done in the reverse order of removal.

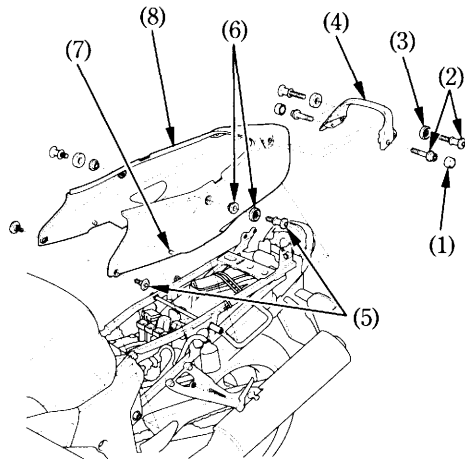

- | | |
|--------------------|---------------|
| (1) Caps | (5) Bolts |
| (2) Bolts | (6) Washers |
| (3) Washers | (7) Prongs |
| (4) Rear grab rail | (8) Rear cowl |

LOWER COWL

Removal:

1. Remove the bolts A (1) and bolts B (2).
2. Remove the clip A (3).

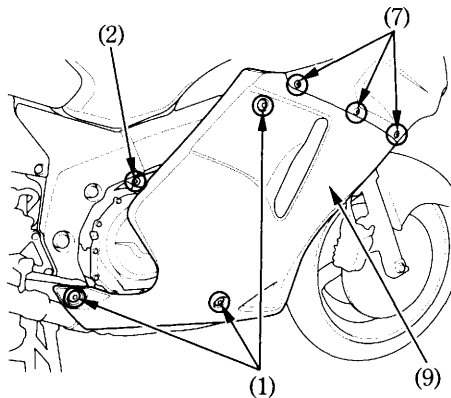

- (1) Bolts A
- (2) Bolts B
- (3) Clip A

- (7) Bolts D
- (9) Right lower cowl

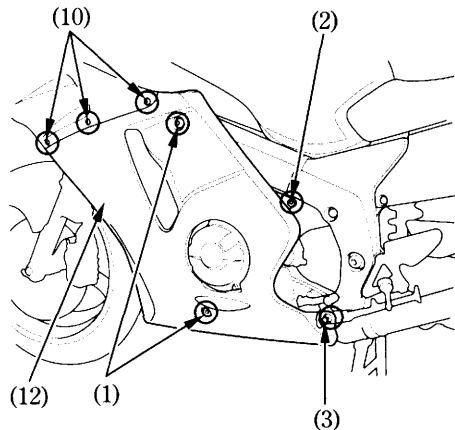

- (10) Bolts E
- (12) Left lower cowl

3. Remove the bolts C (4).
4. Remove the clips B (5) and clips C (6).
5. Remove the bolts D (7).
6. Release the prong (8) of the right lower cowl (9) from the grommet and remove the right lower cowl.
7. Remove the bolts E (10).
8. Release the prong (11) of the left lower cowl (12) from the grommet and remove the left lower cowl.
9. Remove the clips D (13).
10. Remove the inner half cowl (14).

Installation:

- Installation can be done in the reverse order of removal.

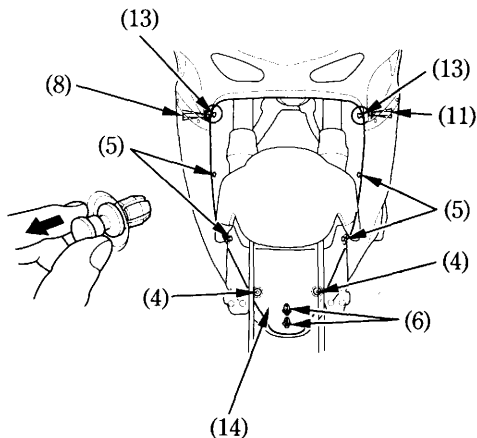

- | | | |
|-------------|------------|----------------------|
| (4) Bolts C | (8) Prong | (13) Clips D |
| (5) Clips B | (11) Prong | (14) Inner half cowl |
| (6) Clips C | | |

UPPER COWL COVER

The right and left upper cowl covers can be removed in the same manner.

Removal:

1. Remove the nut (1) and long mount bolt (2).
2. Remove the short mount bolt (3).
3. Remove the clip (4).
4. Remove the upper cowl cover (5).

Installation:

- Installation can be done in the reverse order of removal.

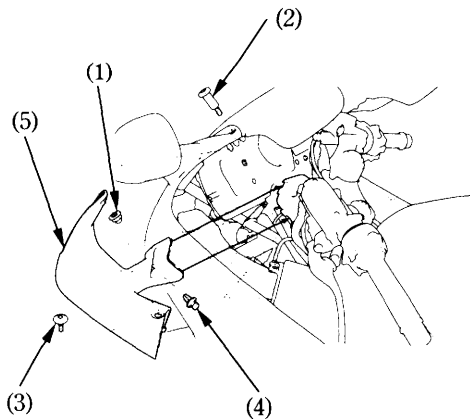

- | | |
|----------------------|----------------------|
| (1) Nut | (4) Clip |
| (2) Long mount bolt | (5) Upper cowl cover |
| (3) Short mount bolt | |

WIND GUARD

The right and left wind guards can be removed in the same manner.

Removal:

1. Remove the upper cowl cover (page 60).
2. Remove the clips A (1).
3. Remove the clips B (2).
4. Remove the wind guards (3).

Installation:

- Installation can be done in the reverse order of removal.

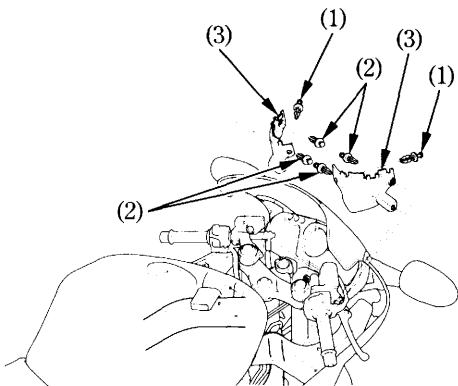

- (1) Clips A
- (2) Clips B
- (3) Wind guards

INNER PANEL

The right and left inner panels can be removed in the same manner.

Removal:

1. Remove the lower cowl (page 58) and upper cowl cover (page 60).
2. Remove the clip A (1).
3. Remove the clip B (2).
4. Remove the inner panel (3) by releasing it from the frame boss (4).
5. Remove the inner panel (3) by releasing it from the grommets (5) on the fuel tank.

Installation:

- Installation can be done in the reverse order of removal.

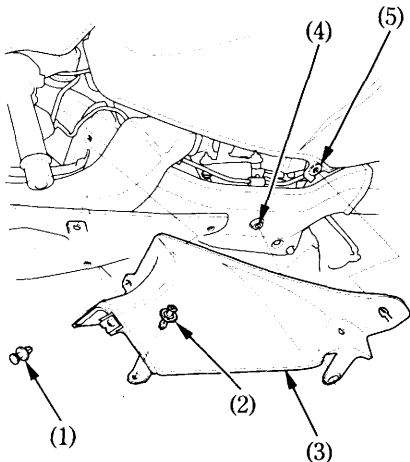

- (1) Clip A
(2) Clip B
(3) Inner panel

- (4) Frame boss
(5) Grommet

HEADLIGHT AIM VERTICAL ADJUSTMENT

Vertical adjustment can be made by turning the knob (1) in or out as necessary.

Remove the upper cowl cover (page 60) to adjust head-light aim.

Obey local laws and regulations.

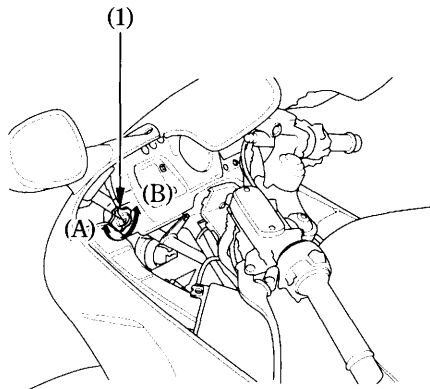

(1) Knob

(A) Up

(B) Down

OPERATION

PRE-RIDE INSPECTION

For your safety, it is very important to take a few moments before each ride to walk around your motorcycle and check its condition. If you detect any problem, be sure you take care of it, or have it corrected by your Honda dealer.

WARNING

Improperly maintaining this motorcycle or failing to correct a problem before riding can cause a crash in which you can be seriously hurt or killed.

Always perform a pre-ride inspection before every ride and correct any problems.

1. Engine oil level—add engine oil if required (page 36). Check for leaks.
2. Fuel level—fill fuel tank when necessary (page 33). Check for leaks.
3. Coolant level—add coolant if required. Check for leaks (pages 31 – 32).
4. Front and rear brakes—check operation; make sure there is no brake fluid leakage (pages 26 – 28).

5. Tyres—check condition and pressure (pages 37 – 42).
6. Drive chain—check condition and slack (page 99). Adjust and lubricate if necessary.
7. Throttle—check for smooth opening and full closing in all steering positions.
8. Lights and horn—check that headlight, stop/tail light, turn signals, indicators and horn function properly.
9. Engine stop switch—check for proper function (pages 49 – 50).
10. Side stand ignition cut-off system—check for proper function (page 107).

STARTING THE ENGINE

Always follow the proper starting procedure described below.

This motorcycle is equipped with a side stand ignition cut-off system. The engine cannot be started if the side stand is down, unless the transmission is in neutral. If the side stand is up, the engine can be started in neutral or in gear with the clutch lever pulled in. After starting with the side stand down, the engine will shut off if the transmission is put in gear before raising the side stand.

Except BR type:

To protect the catalytic converters in your motorcycle's exhaust system, avoid extending idling and the use of leaded petrol.

Your motorcycle's exhaust contains poisonous carbon monoxide gas. High levels of carbon monoxide can collect rapidly in enclosed areas such as a garage. Do not run the engine with the garage door closed. Even with the door open, run the engine only long enough to move your motorcycle out of the garage.

Do not use the electric starter for more than 5 seconds at a time. Release the starter button for approximately 10 seconds before pressing it again.

Preparation

Before starting, insert the key, turn the ignition switch ON and confirm the following:

- The transmission is in NEUTRAL (neutral indicator light ON).
- The engine stop switch is at  (RUN).
- The red low oil pressure indicator is ON.
- The immobilizer system (HISS) indicator is OFF.
- The PGM-FI malfunction indicator lamp (MIL) is OFF.

The low oil pressure indicator should go off a few seconds after the engine starts. If the low oil pressure indicator lights during operation, stop the engine immediately and check the engine oil level.

NOTICE

Operating the engine with insufficient oil pressure can cause serious engine damage.

Starting Procedure

This motorcycle has a fuel-injected engine with an automatic fast idle. Follow the procedure indicated below.

Any Air Temperature

- Press the starter button with the throttle completely closed.

The engine will not start if the throttle is fully open (because the electronic control module cuts off the fuel supply).

Flooded Engine

If the engine fails to start after repeated attempts, it may be flooded.

1. Leave the engine stop switch set to  (RUN).
2. Open throttle fully.
3. Press the starter button for 5 seconds.
4. Follow the normal starting procedure.
5. If the engine starts with unstable idle, open the throttle slightly.

If the engine does not start, wait for 10 seconds, then follow steps 1–4 again.

Ignition Cut Off

Your motorcycle is designed to automatically stop the engine and fuel pump if the motorcycle is over-turned (a banking sensor cuts off the ignition system). Before restarting the engine, you must turn the ignition switch to the OFF position and then back to ON.

RUNNING-IN

Help assure your motorcycle's future reliability and performance by paying extra attention to how you ride during the first 500 km (300 miles).

During this period, avoid full-throttle starts and rapid acceleration.

RIDING

Review Motorcycle Safety (pages 1 – 7) before you ride.

Make sure you understand the function of the side stand mechanism. (See MAINTENANCE SCHEDULE on page 81 and explanation for SIDE STAND on page 107).

〈 Except BR type 〉

Make sure flammable materials such as dry grass or leaves do not come in contact with the exhaust system when riding, idling, or parking your motorcycle.

1. After the engine has been warmed up, the motorcycle is ready for riding.
2. While the engine is idling, pull in the clutch lever and depress the gearshift pedal to shift into 1st (low) gear.
3. Slowly release the clutch lever and at the same time gradually increase engine speed by opening the throttle. Coordination of the throttle and clutch lever will assure a smooth positive start.
4. When the motorcycle attains a moderate speed, close the throttle, pull in the clutch lever and shift to 2nd gear by raising the gearshift pedal.
This sequence is repeated to progressively shift to 3rd, 4th, 5th and 6th(top) gear.

5. Coordinate the throttle and brakes for smooth deceleration.
6. Both front and rear brakes should be used at the same time and should not be applied strongly enough to lock the wheel, or braking effectiveness will be reduced and control of the motorcycle be difficult.

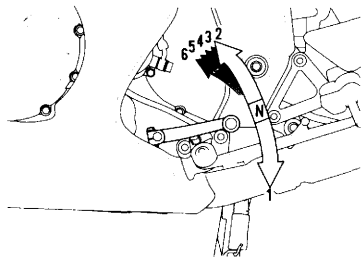

BRAKING

This motorcycle is equipped with a Dual Combined Brake System. Operating the front brake lever applies the front brake and a portion of the rear brake. Operating the rear brake pedal applies the rear brake and a portion of the front brake. For full braking effectiveness, use both the lever and pedal simultaneously, as you would with a conventional motorcycle braking system.

As with a conventional motorcycle braking system, excessively hard application of the brake controls may cause wheel lock, reducing control of the motorcycle.

For normal braking, apply both the brake pedal and lever while down-shifting to match your road speed. For maximum braking, close the throttle and firmly apply the pedal and lever; pull in the clutch lever before coming to a complete stop to prevent stalling the engine.

Important Safety Reminders:

- When possible, reduce speed or brake before entering a turn; closing the throttle or braking in mid-turn may cause wheel slip. Wheel slip will reduce control of the motorcycle.
- When riding in wet or rainy conditions, or on loose surfaces, the ability to maneuver and stop will be reduced. All of your actions should be smooth under these conditions. Rapid acceleration, braking or turning may cause loss of control. For your safety, exercise extreme caution when braking, accelerating or turning.

- When descending a long, steep grade, use engine compression braking by downshifting, with intermittent use of both brakes.

Continuous brake application can overheat the brakes and reduce their effectiveness.

- Riding with your foot resting on the brake pedal or your hand on the brake lever may actuate the brakelight, giving a false indication to other drivers. It may also overheat the brakes, reducing effectiveness.

PARKING

1. After stopping the motorcycle, shift the transmission into neutral, turn the handlebar fully to the left, turn the ignition switch OFF and remove the key.
2. Use the side or center stand to support the motorcycle while parked.

Park the motorcycle on firm, level ground to prevent it from falling over.

If you must park on a slight incline, aim the front of the motorcycle uphill to reduce the possibility of rolling off the side stand or overturning.

3. Lock the steering to help prevent theft (page 52).

〈 Except BR type 〉

Make sure flammable materials such as dry grass or leaves do not come in contact with the exhaust system when parking your motorcycle.

ANTI-THEFT TIPS

1. Always lock the steering and never leave the key in the ignition switch. This sounds simple but people do forget.
2. Be sure the registration information for your motorcycle is accurate and current.
3. Park your motorcycle in a locked garage whenever possible.
4. Use an additional anti-theft device of good quality.
5. Put your name, address, and phone number in this Owner's Manual and keep it on your motorcycles at all times.

Many times stolen motorcycles are identified by information in the Owner's Manuals that are still with them.

NAME: _____

ADDRESS: _____

PHONE NO: _____

MAINTENANCE

THE IMPORTANCE OF MAINTENANCE

A well-maintained motorcycle is essential for safe, economical and trouble-free riding. It will also help reduce air pollution.

To help you properly care for your motorcycle, the following pages include a Maintenance Schedule and a Maintenance Record for regularly scheduled maintenance.

These instructions are based on the assumption that the motorcycle will be used exclusively for its designed purpose. Sustained high speed operation or operation in unusually wet or dusty conditions will require more frequent service than specified in the Maintenance Schedule. Consult your Honda dealer for recommendations applicable to your individual needs and use.

If your motorcycle overturns or becomes involved in a crash, be sure your Honda dealer inspects all major parts, even if you are able to make some repairs.

WARNING

Improperly maintaining this motorcycle or failing to correct a problem before you ride can cause a crash in which you can be seriously hurt or killed.

Always follow the inspection and maintenance recommendations and schedules in this owner's manual.

MAINTENANCE SAFETY

This section includes instructions on some important maintenance tasks. You can perform some of these tasks with the tools provided — if you have basic mechanical skills.

Other tasks that are more difficult and require special tools are best performed by professionals. Wheel removal should normally be handled only by a Honda technician or other qualified mechanic; instructions are included in this manual only to assist in emergency service.

Some of the most important safety precautions follow. However, we cannot warn you of every conceivable hazard that can arise in performing maintenance. Only you can decide whether or not you should perform a given task.

WARNING

Failure to properly follow maintenance instructions and precautions can cause you to be seriously hurt or killed.

Always follow the procedures and precautions in this owner's manual.

SAFETY PRECAUTIONS

- Make sure the engine is off before you begin any maintenance or repairs. This will help eliminate several potential hazards:
 - * **Carbon monoxide poisoning from engine exhaust.**
Be sure there is adequate ventilation whenever you operate the engine.
 - * **Burns from hot parts.**
Let the engine and exhaust system cool before touching.
 - * **Injury from moving parts.**
Do not run the engine unless instructed to do so.
- Read the instructions before you begin, and make sure you have the tools and skills required.
- To help prevent the motorcycle from falling over, park it on a firm, level surface, using the center stand or a maintenance stand to provide support.

- To reduce the possibility of a fire or explosion, be careful when working around petrol or batteries. Use only nonflammable solvent, not petrol, to clean parts. Keep cigarettes, sparks and flames away from the battery and all fuel-related parts.

Remember that your Honda dealer knows your motorcycle best and is fully equipped to maintain and repair it.

To ensure the best quality and reliability, use only new genuine Honda parts or their equivalents for repair and replacement.

MAINTENANCE SCHEDULE

Perform the Pre-ride Inspection (page 64) at each scheduled maintenance period.

I: INSPECT AND CLEAN, ADJUST, LUBRICATE OR REPLACE IF NECESSARY

C: CLEAN R: REPLACE A: ADJUST L: LUBRICATE

The following Maintenance Schedule specifies all maintenance required to keep your motorcycle in peak operating condition. Maintenance work should be performed in accordance with standards and specifications of Honda by properly trained and equipped technicians. Your Honda dealer meets all of these requirements.

- * Should be serviced by your Honda dealer, unless the owner has proper tools and service data and is mechanically qualified. Refer to the Official Honda Shop Manual.
- ** In the interest of safety, we recommend these items be serviced only by your Honda dealer.

Honda recommends that your Honda dealer should road test your motorcycle after each periodic maintenance is carried out.

- NOTES:
- (1) At higher odometer readings, repeat at the frequency interval established here.
 - (2) Service more frequently if the motorcycle is ridden in unusually wet or dusty areas.
 - (3) Replace every 2 years, or at indicated odometer interval, whichever comes first. Replacement requires mechanical skill.

ITEM	FREQUENCY	WHICHEVER → COMES FIRST ↓ NOTE	ODOMETER READING [NOTE (1)]								REFER TO PAGE
			× 1,000 km	1	6	12	18	24	30	36	
			× 1,000 mi	0.6	4	8	12	16	20	24	
		NOTE	MONTH								
* FUEL LINE					I		I		I	—	
* THROTTLE OPERATION					I		I		I	96	
* AIR CLEANER		NOTE (2)				R			R	—	
SPARK PLUGS					EVERY 24,000 km (16,000 mi) I, EVERY 48,000 km (32,000 mi) R					91-95	
* VALVE CLEARANCE							I			—	
ENGINE OIL			R		R		R		R	85-90	
ENGINE OIL FILTER			R		R		R		R	88-90	
* ENGINE IDLE SPEED			I	I	I	I	I	I	I	97	
RADIATOR COOLANT		NOTE (3)			I		I		R	31-32	
* COOLING SYSTEM					I		I		I	—	
* SECONDARY AIR SUPPLY SYSTEM					I		I		I	—	

ITEM	FREQUENCY	WHICHEVER → COMES FIRST ↓ NOTE	ODOMETER READING [NOTE (1)]							REFER TO PAGE	
			× 1,000 km	1	6	12	18	24	30		36
			× 1,000 mi	0.6	4	8	12	16	20		24
DRIVE CHAIN			EVERY 1,000 km (600 mi) I, L							99-104	
DRIVE CHAIN SLIDER					I			I		I	105
BRAKE FLUID		NOTE (3)		I	I	R		I	I	R	26-28
BRAKE PAD WEAR				I	I	I		I	I	I	116
BRAKE SYSTEM			I		I			I		I	26-28, 118
* BRAKE LIGHT SWITCH					I			I		I	124
* HEADLIGHT AIM					I			I		I	63
CLUTCH SYSTEM					I			I		I	29
CLUTCH FLUID		NOTE (3)		I	I	R		I	I	R	29
SIDE STAND					I			I		I	107
* SUSPENSION					I			I		I	106
* NUTS, BOLTS, FASTENERS			I		I			I		I	-
** WHEELS/TYRES					I			I		I	-
** STEERING HEAD BEARINGS			I		I			I		I	-

TOOL KIT

The tool kit (1) is in the tool box under the seat.

Some roadside repairs, minor adjustments and parts replacement can be performed with the tools contained in the kit.

- Spark plug wrench
- 10 × 12 mm Box end wrench
- 22 mm Box end wrench
- 27 mm Box end wrench
- 8 mm Open end wrench
- 10 × 12 mm Open end wrench
- Pliers
- 5 mm Hex wrench
- 6 mm Hex wrench
- Screwdriver handle
- Tool bag
- Extension bar
- 0.7 mm Feeler gauge
- Standard/Phillips screwdriver
- 8 mm Box wrench

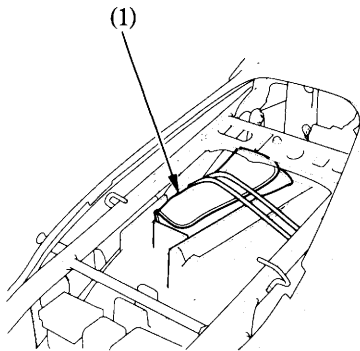

(1) Tool kit

SERIAL NUMBERS

The frame and engine serial numbers are required when registering your motorcycle. They may also be required by your dealer when ordering replacement parts. Record the numbers here for your reference.

FRAME NO. _____

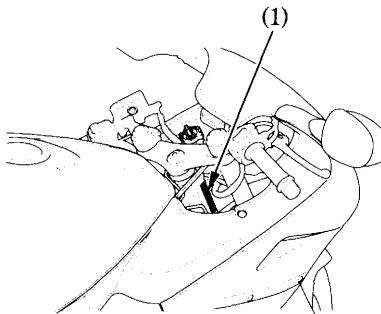

(1) Frame number

The frame number (1) is stamped on the right side of the steering head.

The engine number (2) is stamped on top of the crankcase.

ENGINE NO. _____

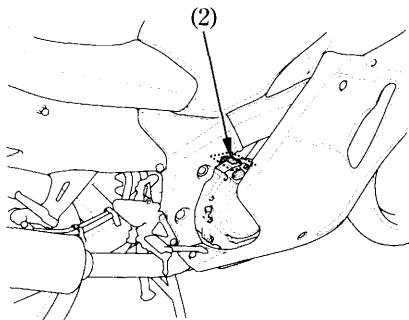

(2) Engine number

COLOUR LABEL

The colour label (1) is attached to the frame below the seat (page 54).

It is helpful when ordering replacement parts. Record the colour and code here for your reference.

COLOUR _____

CODE _____

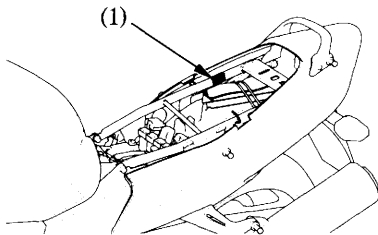

(1) Colour label

ENGINE OIL

Refer to the Safety Precautions on page 78 .

Oil Recommendation

API classification	SG or higher except oils labeled as energy conserving on the circular API service label
Viscosity	SAE 10W-40
JASO T 903 standard	MA

Suggested Oil
Honda "4-STROKE MOTORCYCLE OIL" or equivalent.

Your motorcycle does not need oil additives. Use the recommended oil.

Do not use oils with graphite or molybdenum additives. They may adversely affect clutch operation.

Do not use API SH or higher oils displaying a circular API "energy conserving" service label on the container. They may affect lubrication and clutch performance.

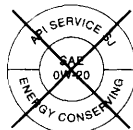

NOT RECOMMENDED



OK

Do not use non-detergent, vegetable, or castor based racing oils.

Viscosity:

Viscosity grade of engine oil should be based on average atmospheric temperature in your riding area. The following provides a guide to the selection of the proper grade or viscosity of oil to be used at various atmospheric temperatures.

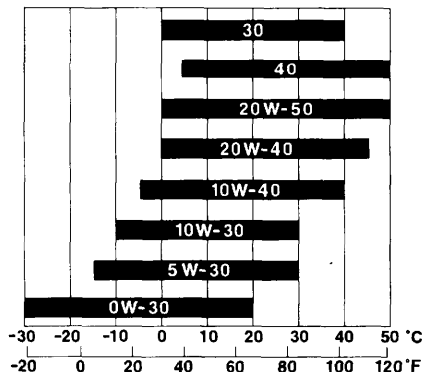

JASO T 903 standard

The JASO T 903 standard is an index for choosing engine oils for 4-stroke motorcycle engines.

There are two classes: MA and MB.

Oil conforming to the standard is labeled on the oil container. For example, the following label shows the MA classification.

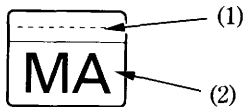

PRODUCT MEETING JASO T 903
COMPANY GUARANTEEING THIS MA PERFORMANCE:

- (1) Code number of the sales company of the oil
- (2) Oil classification

Engine Oil and Filter

Engine oil quality is the chief factor affecting engine service life. Change the engine oil as specified in the maintenance schedule (page 80).

When running in very dusty conditions, oil changes should be performed more frequently than specified in the maintenance schedule.

Please dispose of used engine oil in a manner that is compatible with the environment. We suggest you take it in a sealed container to your local recycling center or service station for reclamation. Do not throw it in the trash or pour it on the ground or down a drain.

Used engine oil may cause skin cancer if repeatedly left in contact with the skin for prolonged periods. Although this is unlikely unless you handle used oil on a daily basis, it is still advisable to thoroughly wash your hands with soap and water as soon as possible after handling used oil.

Changing the oil filter requires a special oil filter tool and a torque wrench. If you do not have these tools and the necessary skill, we recommend that you have your Honda dealer perform this service.

If a torque wrench is not used for this installation, see your Honda dealer as soon as possible to verify proper assembly.

Change the engine oil with the engine at normal operating temperature and the motorcycle on its center stand to assure complete and rapid draining.

1. Remove the lower cowl (page 58).
2. To drain the oil, remove the oil filler cap and oil drain plug (1) and sealing washer (2).

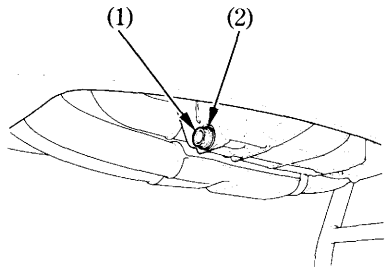

(1) Oil drain plug (2) Sealing washer

3. Remove the oil filter (3) with a filter wrench and let the remaining oil drain out.

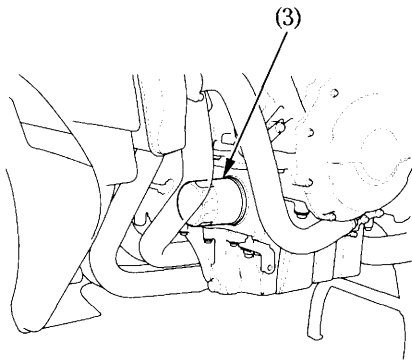

(3) Oil filter

4. Apply a thin coat of engine oil to the new oil filter rubber seal (4).
5. Using a special tool and a torque wrench, install the new oil filter and tighten to a torque of:
10 N·m (1.0 kgf·m , 7 lbf·ft)

Use only the Honda genuine oil filter or a filter of equivalent quality specified for your model. Using the wrong Honda filter or a non-Honda filter which is not of equivalent quality may cause engine damage.

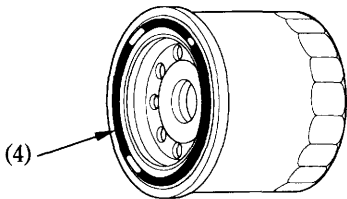

(4) Oil filter rubber seal

6. Check that the sealing washer on the drain plug is in good condition and install the plug. Replace the sealing washer every other time the oil is changed, or each time if necessary.
Oil drain plug Torque:
30 N·m (3.0 kgf·m , 22 lbf·ft)
7. Fill the crankcase with the recommended grade oil; approximately:
3.9 l (4.1 US qt , 3.4 Imp qt)
8. Install the oil filler cap.
9. Install the lower cowl.
10. Start the engine and let it idle for 3–5 minutes.
11. 2–3 minutes after stopping the engine, check that the oil level is at the upper level mark on the dipstick with the motorcycle on its center stand, level ground. Make sure there are no oil leaks.

SPARK PLUGS

Refer to the Safety Precautions on page 78 .

Recommended plugs:

IMR9C – 9H (NGK)

NOTICE

Never use a spark plug with an improper heat range. Severe engine damage could result.

This motorcycle uses the spark plugs that have an iridium coated center electrode. Be sure to observe the following when servicing the spark plugs.

- Do not clean the spark plug. If the electrode is contaminated with accumulated objects or dirt, replace the spark plug with a new one.
- Use only “wire-type feeler gauge” to check the spark plug gap to prevent damaging the iridium coating of the center electrodes. Never use “leaf-type feeler gauge”.
- Do not adjust the spark plug gap. If the gap is out of specification, replace the spark plug with a new one.

1. Remove the lower cowl (page 58).
2. Remove the upper cowl cover (page 60).
3. Remove the wind guard (page 61).
4. Remove the inner panel (page 62).
5. Remove the oil cooler upper mount bolts (1) and harness guide (2).
6. Remove the oil cooler lower mount bolts (3).
7. Move the oil cooler (4) forward.

NOTICE

Damage to the oil cooler fins can reduce cooling or cause a system leak. Handle the oil cooler with care.

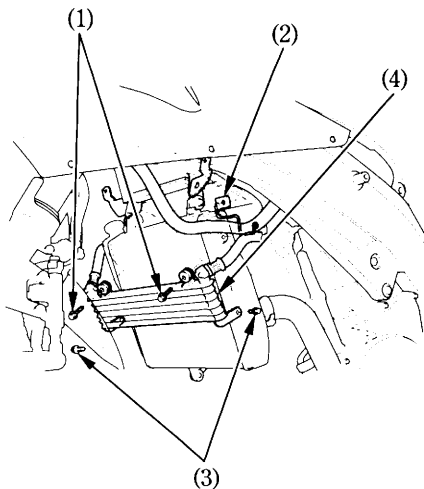

- | | |
|-----------------------|-----------------------|
| (1) Upper mount bolts | (3) Lower mount bolts |
| (2) Harness guide | (4) Oil cooler |

8. Remove the radiator mount bolt (5).
9. Move the radiator (6) out of the way and remove the grommets (7) from the radiator stays (8).
10. Pull the radiator toward the front.

NOTICE

Damage to the radiator fins can reduce cooling or cause a system leak. Handle the radiator with care.

11. Remove the heat guard (9) from the radiator stay (8).

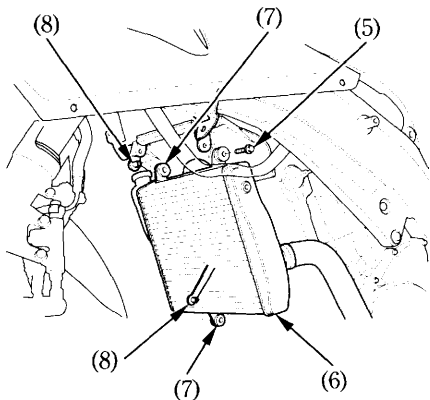

- | | |
|-------------------------|--------------------|
| (5) Radiator mount bolt | (7) Grommets |
| (6) Radiator | (8) Radiator stays |

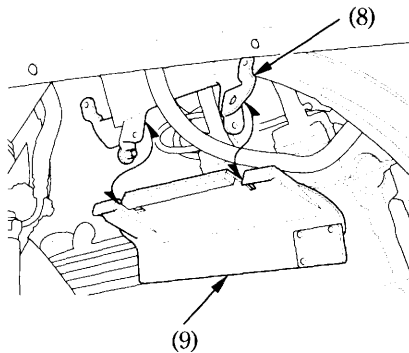

- | |
|----------------|
| (9) Heat guard |
|----------------|

12. Disconnect the spark plug caps from the spark plugs.
13. Clean any dirt from around the spark plug bases.
Remove the spark plugs using the spark plug wrench (10) furnished in the tool kit.
14. Inspect the electrodes and center porcelain for deposits, erosion or carbon fouling. If the erosion or deposit is heavy, replace the plug.

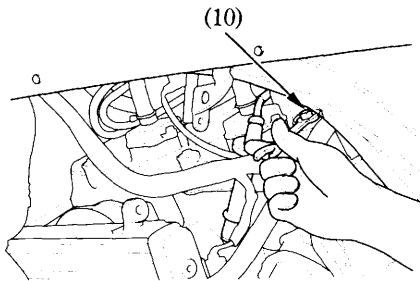

(10) Spark plug wrench

15. Make sure that the 1.0 mm wire-type feeler gauge does not insert between the spark plug gap (11). If the gauge is inserted into the gap, replace the plug with a new one.
16. Make sure the plug washer is in good condition.

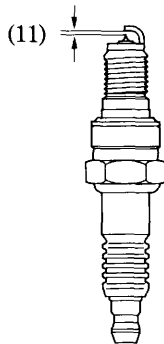

(11) Spark plug gap

17. With the plug washer attached, thread the spark plug in by hand to prevent cross-threading.
18. Tighten the spark plug:
 - If the old plug is good:
1/8 turn after it seats.
 - If installing a new plug, tighten it twice to prevent loosening:
 - a) First, tighten the plug:
NGK: 1/2 turn after it seats.
 - b) Then loosen the plug.
 - c) Next, tighten the plug again:
1/8 turn after it seats.

NOTICE

Improperly tightened spark plug can damage the engine. If a plug is too loose, a piston may be damaged. If a plug is too tight, the threads may be damaged.

19. Reinstall the spark plug caps.
20. Install the remaining parts in the reverse order of removal.

NOTICE

To avoid possible costly damage to the radiator, do not install the upper (longer) mount bolts in the lower mounts. Also avoid cross-threading or overtightening the oil cooler lower mount bolts (3) (page 92).

THROTTLE OPERATION

Refer to the Safety Precautions on page 78 .

1. Check for smooth rotation of the throttle grip from the fully open to the fully closed position at both full steering positions.
2. Measure the throttle grip freeplay at the throttle grip flange.
The standard freeplay should be approximately:
2 – 6 mm (0.08 – 0.24 in)

To adjust the freeplay, loosen the lock nut (1) and turn the adjuster (2).

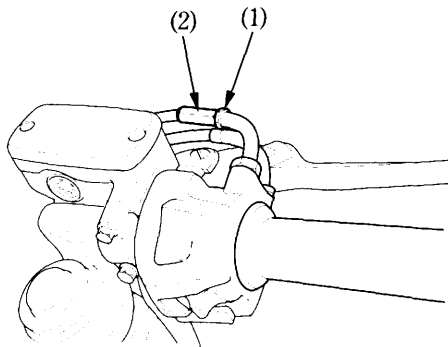

(1) Lock nut

(2) Adjuster

IDLE SPEED

Refer to the Safety Precautions on page 78 .

The engine must be at normal operating temperature for accurate idle speed adjustment. 10 minutes of stop-and-go riding is sufficient.

1. Warm up the engine, and shift to neutral, and place the motorcycle on its center stand.
2. Adjust idle speed with the throttle stop screw (1).

Idle speed (In neutral):

$1,100 \pm 100 \text{ min}^{-1} (\text{rpm})$

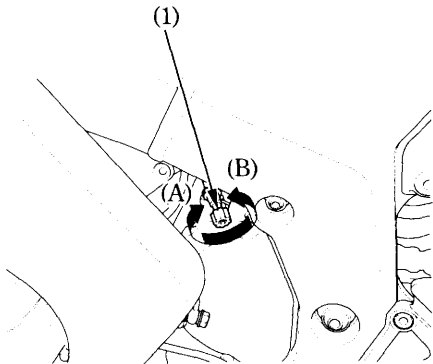

(1) Throttle stop screw

(A) Increase

(B) Decrease

COOLANT

Refer to the Safety Precautions on page 78 .

Coolant Replacement

Coolant should be replaced by a Honda dealer, unless the owner has proper tools and service data and is mechanically qualified. Refer to an official Honda Shop Manual.

Always add coolant to the reserve tank. Do not attempt to add coolant by removing the radiator cap.

WARNING

Removing the radiator cap while the engine is hot can cause the coolant to spray out, seriously scalding you.

Always let the engine and radiator cool down before removing the radiator cap.

DRIVE CHAIN

Refer to the Safety Precautions on page 78 .

The service life of the drive chain is dependent upon proper lubrication and adjustment. Poor maintenance can cause premature wear or damage to the drive chain and sprockets.

The drive chain should be checked and lubricated as part of the Pre-ride Inspection (page 64). Under severe usage, or when the motorcycle is ridden in unusually dusty or muddy areas, more frequent maintenance will be necessary.

Inspection:

1. Turn the engine off, place the motorcycle on its center stand, and shift the transmission into neutral.
2. Check slack in the lower drive chain run midway between the sprockets.
Drive chain slack should be adjusted to allow the following vertical movement by hand:

25 – 35 mm (1.0 – 1.4 in)

3. Rotate the rear wheel. Stop. Check the drive chain slack. Repeat this procedure several times. Drive chain slack should remain constant. If the chain is slack only in certain sections, some links are kinked and binding. Binding and kinking can frequently be eliminated by lubrication.

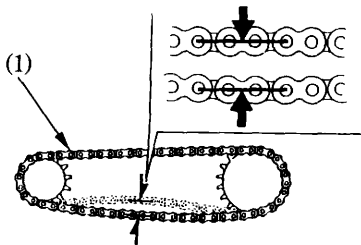

(1) Drive chain

4. Rotate the rear wheel slowly and inspect the drive chain and sprockets for any of the following conditions:

DRIVE CHAIN

- *Damaged Rollers
- *Loose Pins
- *Dry or Rusted Links
- *Kinked or Binding Links
- *Excessive Wear
- *Improper Adjustment
- *Damaged or Missing O-rings

SPROCKETS

- *Excessively Worn Teeth
- *Broken or Damaged Teeth

A drive chain with damaged rollers, loose pins, or missing O-rings must be replaced. A chain which appears dry, or shows signs of rust, requires supplementary lubrication. Kinked or binding links should be thoroughly lubricated and worked free. If links cannot be freed, the chain must be replaced.

Damaged sprocket
Teeth

Replace

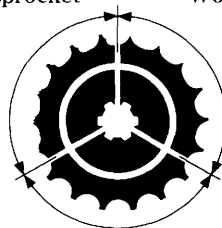

Worn sprocket
Teeth

Replace

Normal sprocket Teeth

GOOD

Adjustment:

Drive chain slack should be checked and adjusted, if necessary, every 1,000 km (600 miles). When operated at sustained high speeds or under conditions of frequent rapid acceleration, the chain may require more frequent adjustment.

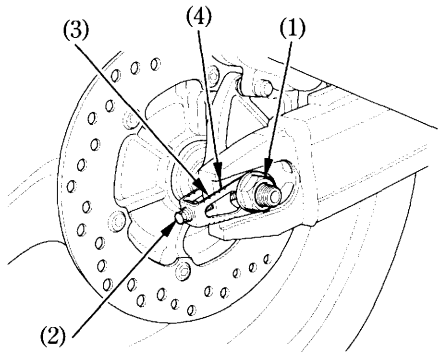

- (1) Axle nut (3) Scale
(2) Adjusting bolt (4) Index mark

If the drive chain requires adjustment, the procedure is as follows:

1. Place the motorcycle on its center stand with the transmission in neutral and the ignition switch off.
2. Loosen the axle nut (1).
3. Turn both adjusting bolts (2) an equal number of turns until the correct drive chain slack is obtained. Turn the adjusting bolts counterclockwise to tighten the chain, or clockwise to provide more slack. Adjust the chain slack at a point midway between the drive sprocket and the rear wheel sprocket. Rotate the rear wheel and recheck slack at other sections of the chain.

Chain slack should be:

25–35 mm (1.0–1.4 in)

4. Check the rear axle alignment by confirming the scale (3) on the drive chain adjusters against the index marks (4) on the swingarm.

Both left and right scales should correspond. If the axle is misaligned, turn the left or right adjusting bolt until the scales correspond on both sides of the swingarm and recheck chain slack.

5. Tighten the axle nut to specified torque.

Axle nut torque:

93 N·m (9.5 kgf·m , 69 lbf·ft)

If a torque wrench is not used for this installation, see your Honda dealer as soon as possible to verify proper assembly.

6. Tighten the adjusting bolts lightly.

Wear Inspection:

Check the chain wear label when adjusting the chain. If the red zone (6) on the label aligns with the index mark (5) on the swingarm after the chain has been adjusted to the proper slack, the chain is excessively worn and must be replaced. The proper slack is:

25 – 35 mm (1.0 – 1.4 in)

Damage to the bottom part of the frame may be caused by excessive drive chain slack of more than:

50 mm (2.0 in)

Replacement chain:

D.I.D.50ZVS

or

RK50LFO – Z1

This motorcycle has a staked master link drive chain which requires a special tool for cutting and staking. Do not use an ordinary master link with this chain. See your Honda dealer.

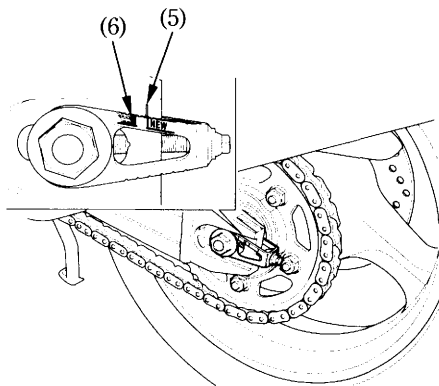

(5) Index mark

(6) Red zone

Lubrication and Cleaning:

Lubricate every 1,000 km (600 miles) or sooner if chain appears dry.

The drive chain on this motorcycle is equipped with small O-rings between the link plates. These O-rings retain grease inside the chain to improve its service life.

The O-rings in this chain can be damaged by steam cleaning, high pressure washers, and certain solvents. Clean the side surfaces of the chain with a dry cloth. Do not brush the rubber O-rings. Brushing will damage them. Wipe dry and lubricate only with SAE 80 or 90 gear oil. Commercial chain lubricants may contain solvents which could damage the rubber O-rings.

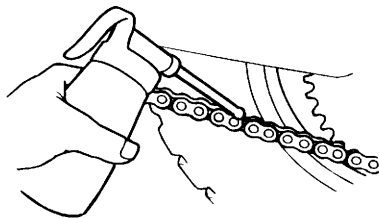

DRIVE CHAIN SLIDER

Refer to the Safety Precautions on page 78 .

Check the chain slider (1) for wear.
The chain slider must be replaced if it is worn to the wear limit line (2). For replacement, see your Honda dealer.

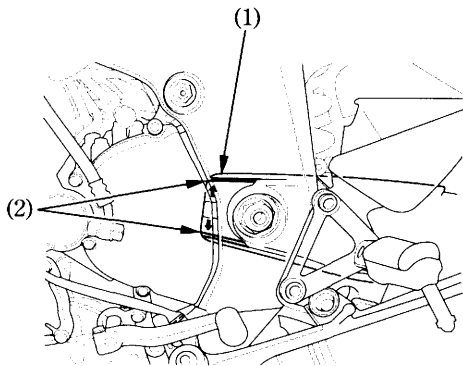

- (1) Chain slider
- (2) Wear limit line

FRONT AND REAR SUSPENSION INSPECTION

Refer to the Safety Precautions on page 78 .

1. Check the fork assembly by locking the front brake and pumping the fork up and down vigorously. Suspension action should be smooth and there must be no oil leakage.
2. Swingarm bearings should be checked by pushing hard against the side of the rear wheel while the motorcycle is on the center stand. Free play indicates worn bearings.
3. Carefully inspect all front and rear suspension fasteners for tightness.

SIDE STAND

Refer to the Safety Precautions on page 78 .

Perform the following maintenance in accordance with the maintenance schedule.

Functional Check:

- Check the spring (1) for damage or loss of tension and the side stand assembly for freedom of movement.
- Check the side stand ignition cut-off system:
 1. Sit astride the motorcycle; put the side stand up and the transmission in neutral.
 2. Start the engine and with the clutch lever pulled in, shift the transmission into gear.
 3. Lower the side stand. The engine should stop as you put the side stand down.

If the side stand system does not operate as described, see your Honda dealer for service.

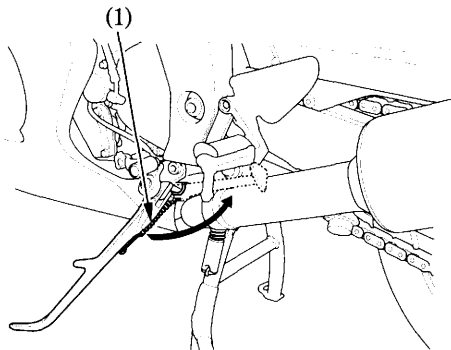

(1) Side stand spring

WHEEL REMOVAL

Refer to the Safety Precautions on page 78 .

Front Wheel Removal

1. Raise the front wheel off the ground by placing a support block under the engine.
2. Cover both sides of the front wheel with a protective tape (1) or equivalent.

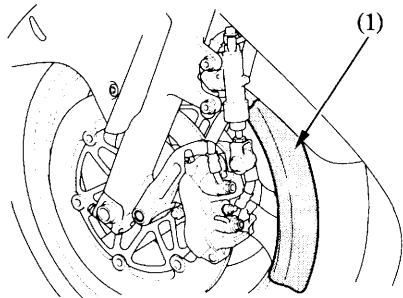

(1) Protective tape

3. Remove the two A socket bolts (2) and the B socket bolt (3).

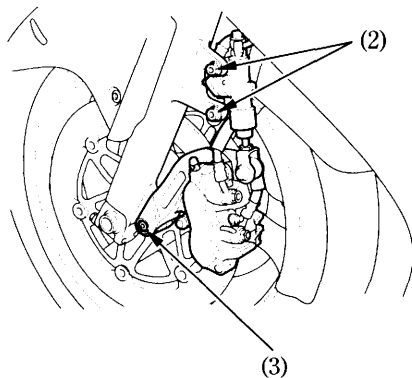

(2) Socket bolts A

(3) Socket bolt B

4. Remove the left caliper assembly (4).
5. Remove the right caliper assembly (5) from the fork leg by removing the fixing bolts (6).

To avoid damage to the brake hose, support the caliper assembly so that it doesn't hang from the hose. Do not twist the brake hose.

Do not depress the brake lever and brake pedal when the wheel is off the motorcycle. The caliper piston will be forced out of the cylinder with subsequent loss of brake fluid. If this occurs, servicing of the brake system will be necessary. See your Honda dealer for this service.

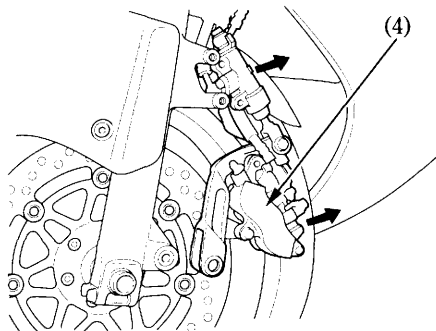

(4) Left caliper assembly

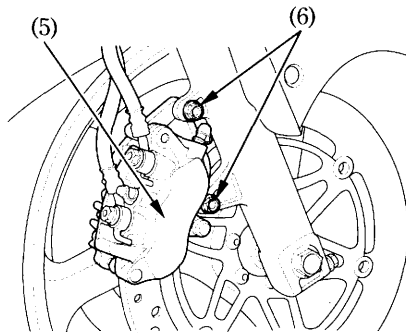

(5) Right caliper assembly (6) Fixing bolts

6. Loosen the right and left axle pinch bolts (7), and remove the front axle bolt (8).
7. Withdraw the front axle shaft (9) and remove the front wheel.

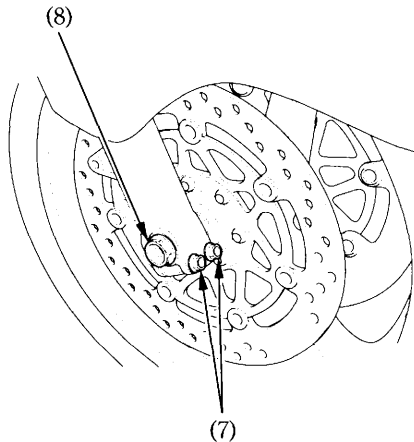

(7) Axle pinch bolts

(8) Axle bolt

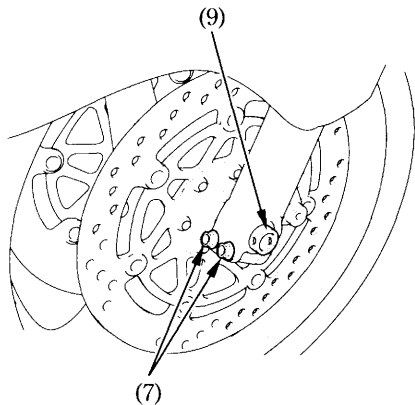

(9) Front axle shaft

Installation:

1. Position the front wheel between the fork legs and insert the front axle shaft from the left side, through the left fork leg and wheel hub.
2. Tighten the axle bolt to the specified torque:
59 N·m (6.0 kgf·m , 43 lbf·ft)
3. Tighten the axle pinch bolts on the right fork leg to specified torque:
22 N·m (2.2 kgf·m , 16 lbf·ft)

4. Install the right and left caliper assembly to the fork legs, tighten the fixing bolts and socket bolts to the specified torque:
31 N·m (3.2 kgf·m , 23 lbf·ft)
To avoid damaging the brake pads while installing the caliper assemblies, carefully fit both brake discs between the pads.
5. Temporarily tighten the axle pinch bolts on the left fork leg until they lightly seat.
6. Operate the front brake and pump the fork several times.

7. Measure the clearance (10) between each surface of the left brake disc (11) and the left brake caliper holder (12) (not brake pads) with a 0.7 mm (0.028 in) feeler gauge (13) (see illustration).

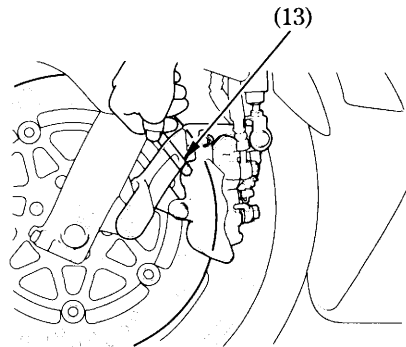
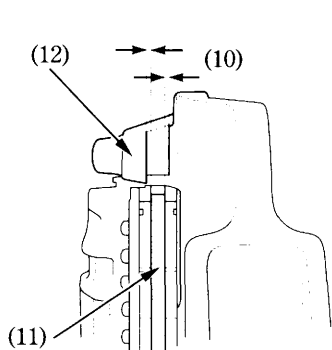

(10) Clearance
(11) Brake disc

(12) Caliper holder

(13) Feeler gauge

8. If the feeler gauge inserts easily, tighten the left axle pinch bolts (7) to the specified torque:

22 N·m (2.2 kgf·m , 16 lbf·ft)

If the feeler gauge cannot be inserted easily, pull the left fork outward or push inward to adjust the clearance. Then tighten the left axle pinch bolts to the specified torque.

9. After installing the wheel, apply the brake lever AND brake pedal several times, then recheck both discs for caliper holder to disc clearance. Do not operate the motorcycle without adequate clearance.

- Check for free wheel rotation after the brake lever and brake pedal are released. Recheck the wheel if the brake drags or if the wheel does not rotate freely.
- After installing the wheel, operate the brake lever AND brake pedal several times until you feel pressure. You must restore pressure from BOTH the lever AND the pedal because this motorcycle is equipped with a Dual Combined Brake System.

- Verify proper brake operation before riding.

10. Remove the protective tapes from the front wheel.

Failure to provide adequate disc to caliper holder (not brake pads) clearance may damage the brake discs and impair braking efficiency.

If the torque wrench was not used for installation, see your Honda dealer as soon as possible to verify proper assembly. Improper assembly may lead to loss of braking capacity.

Rear Wheel Removal

1. Place the motorcycle on its center stand.
2. Loosen the rear axle nut (1).
3. Loosen the drive chain adjusting bolts (2).
4. Remove the rear axle nut.
5. Remove the drive chain (3) from the driven sprocket by pushing the rear wheel forward.

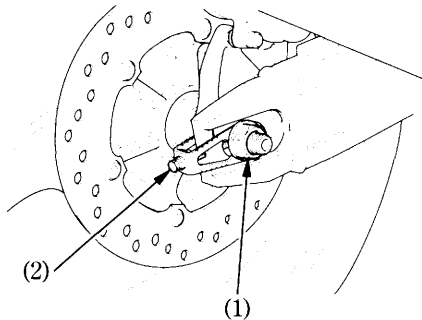

(1) Rear axle nut

6. Remove the rear axle shaft (4), side collar and rear wheel from the swingarm.

Do not depress the brake lever and brake pedal when the wheel is off the motorcycle. The caliper piston will be forced out of the cylinder with subsequent loss of brake fluid. If this occurs, servicing of the brake system will be necessary. See your Honda dealer for this service.

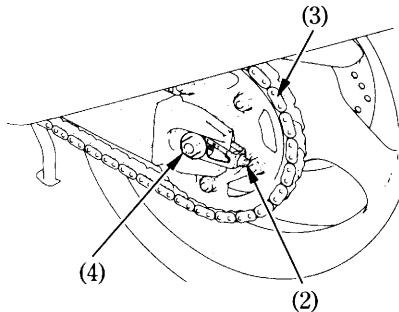

(2) Adjusting bolt

(4) Rear axle shaft

(3) Drive chain

Installation Notes:

- To install the rear wheel, reverse the removal procedure.
- Make sure that the slot (5) on the brake caliper is located in the lug (6) in the swingarm (7).
- Tighten the axle nut to:
93 N·m (9.5 kgf·m , 69 lbf·ft)
- Adjust the drive chain (page 99).
- Apply the brake several times and check for free wheel rotation after the brake lever and brake pedal are released.
- Brake system inspection (page 118).

When installing the wheel, carefully fit the brake disc between the brake pads to avoid damaging the pads.

After installation, operate the brake lever and brake pedal and check the brake operation.

If a torque wrench was not used for installation, see your Honda dealer as soon as possible to verify proper assembly. Improper assembly may lead to loss of braking capacity.

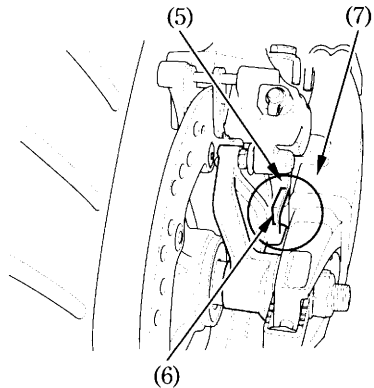

(5) Slot
(6) Lug

(7) Swingarm

BRAKE PAD WEAR

Refer to the Safety Precautions on page 78 .

Brake pad wear depends upon the severity of usage, the type of riding, and road conditions. (Generally, the pads will wear faster on wet and dirty roads.)

Inspect the pads at each regular maintenance interval (page 81).

Front Brake

Always inspect each pad in both right and left brake calipers.

Check the cutout (1) in each pad.

If either pad is worn to the cutout, replace both pads as a set. See your Honda dealer for this service.

< FRONT BRAKE >

Illustration shows left side, right side similar.

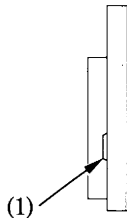
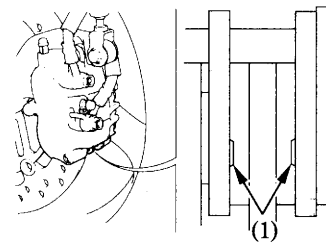

(1) Cutouts

Rear Brake

Check the cutout (2) in each pad.
If either pad is worn to the cutout, replace both pads as a set. See your Honda dealer for this service.

< REAR BRAKE >

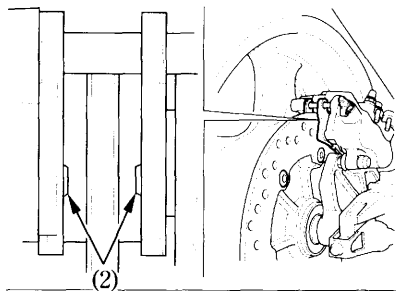

(2) Cutouts

BRAKE SYSTEM INSPECTION

Refer to the Safety Precautions on page 78 .

Check the brake system as follows:

1. Place the motorcycle on its center stand, stop the engine, and place the transmission in neutral.

2. Move the left caliper assembly (1) upward while slowly rotating the rear wheel. The brake system is normal if the rear wheel stops. If the rear wheel does not stop, see your Honda dealer.

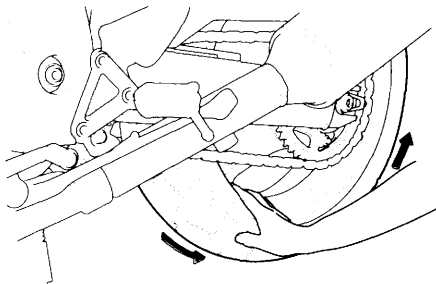
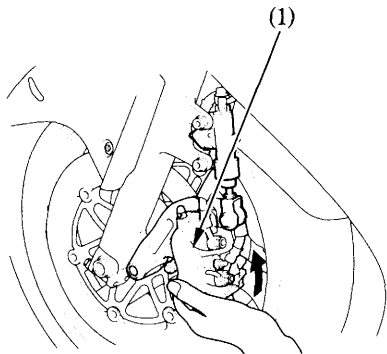

(1) Left caliper assembly

BATTERY

Refer to the Safety Precautions on page 78 .

It is not necessary to check the battery electrolyte level or add distilled water as the battery is a maintenance-free (sealed) type. If your battery seems weak and/or is leaking electrolyte (causing hard starting or other electrical troubles), contact your Honda dealer.

NOTICE

Your battery is a maintenance-free type and can be permanently damaged if the cap strip is removed.

⚠ WARNING

The battery gives off explosive hydrogen gas during normal operation.

A spark or flame can cause the battery to explode with enough force to kill or seriously hurt you.

Wear protective clothing and a face shield, or have a skilled mechanic do the battery maintenance.

Battery Removal

1. Remove the seat (page 54).
2. Release the rings and remove the rubber band (1).
3. Disconnect the negative (-) terminal lead (2) from the battery first, then disconnect the positive (+) terminal lead (3).
4. Pull out the battery (4) from the battery box.

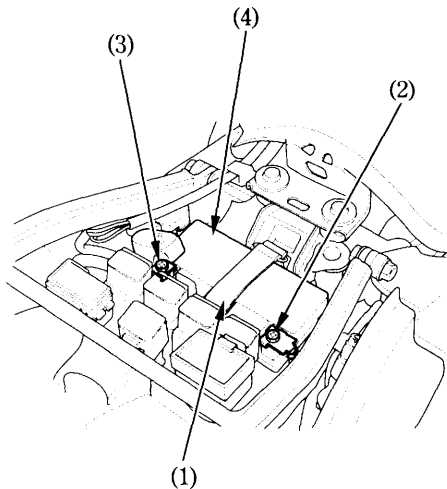

- (1) Rubber band
- (2) Negative (-) terminal lead
- (3) Positive (+) terminal lead
- (4) Battery

FUSE REPLACEMENT

Refer to the Safety Precautions on page 78 .

When frequent fuse failure occurs, it usually indicates a short circuit or an overload in the electrical system. See your Honda dealer for repair.

NOTICE

Never use a fuse with a different rating from that specified. Serious damage to the electrical system or a fire may result, causing a dangerous loss of lights or engine power.

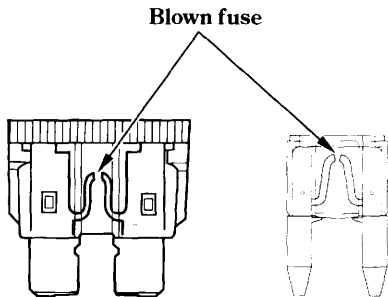

Fuse Box:

The fuse box is located under the seat.

The specified fuses are:

10A, 20A

1. Remove the seat (page 54).
2. Open the fuse box cover (1).
3. Pull out the old fuse and install a new fuse.
The spare fuses (2) are located in the fuse box.
4. Close the fuse box cover and install the seat.

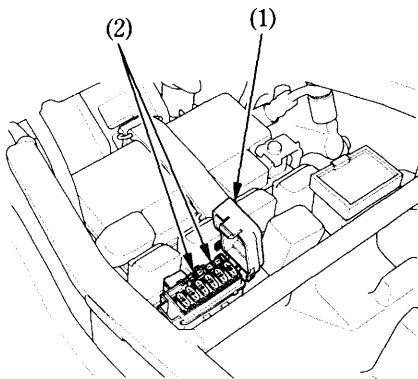

- (1) Fuse box cover
(2) Spare fuses

Main Fuse A:

The main fuse A (1) is located behind the rear cowl.

The specified fuse is:

30A

1. Remove the rear cowl (page 57).
2. Disconnect the wire connector (2) of the starter magnetic switch.
3. Pull out the old fuse and install a new fuse.
The spare fuse (3) is located under the starter magnetic switch.
4. Reconnect the connector and install the rear cowl.

FI Fuse:

The FI fuse (4) is located under the seat.

The specified fuse is:

30A

1. Remove the seat (page 54).
2. Open the FI fuse box cover (5).
3. Pull out the old fuse and install a new fuse.
The spare fuse (3) is located under the starter magnetic switch.
4. Close the FI fuse box cover and install the seat.

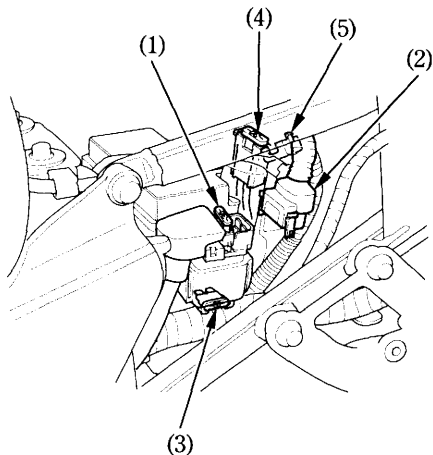

- (1) Main fuse A
(2) Wire connector
(3) Spare main fuse

- (4) FI fuse
(5) FI fuse box cover

STOPLIGHT SWITCH ADJUSTMENT

Refer to the Safety Precautions on page 78 .

Check the operation of the stoplight switch (1) at the right side behind the engine from time to time.

Adjustment is done by turning the adjusting nut (2). Turn the nut in the direction (A) if the switch operates too late and in direction (B) if the switch operates too soon.

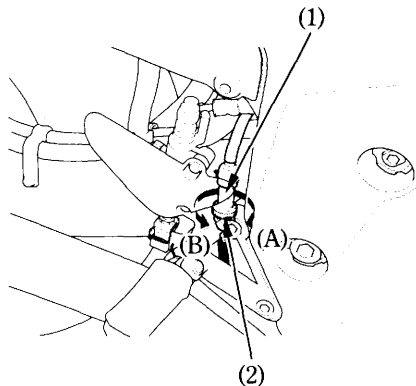

- (1) Stoplight switch
- (2) Adjusting nut

BULB REPLACEMENT

Refer to the Safety Precautions on page 78 .

The light bulb becomes very hot while the light is ON, and remains hot for a while after it is turned OFF. Be sure to let it cool down before servicing.

Do not put finger prints on the headlight bulb, as they may create hot spots on the bulb and cause it to break.

Wear clean gloves while replacing the bulb. If you touch the bulb with your bare hands, clean it with a cloth moistened with alcohol to prevent its early failure.

- Be sure to turn the ignition switch OFF when replacing the bulb.
- Do not use bulbs other than those specified.
- After installing a new bulb, check that the light operates properly.

Headlight Bulb

1. Remove the upper cowl cover (page 60).
2. Pull out the socket (1) without turning.
3. Remove the dust cover (2).
4. Remove the bulb (4) while pressing down on the pin (3).
5. Pull out the bulb (4) without turning.
6. Install a new bulb in the reverse order of removal.
 - Install the dust cover with its “TOP” mark facing up.

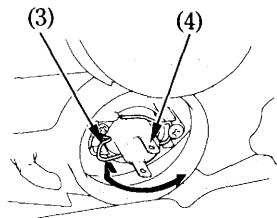
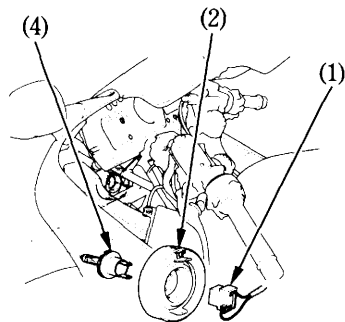

(1) Socket
(2) Dust cover

(3) Pin
(4) Bulb

Position Light Bulb

< Except U, IIUtype >

1. Remove the position light cover (1).
2. Pull the position light reflector (2) and remove it.
3. Pull out the bulb (3) without turning.
4. Install a new bulb in the reverse order of removal.

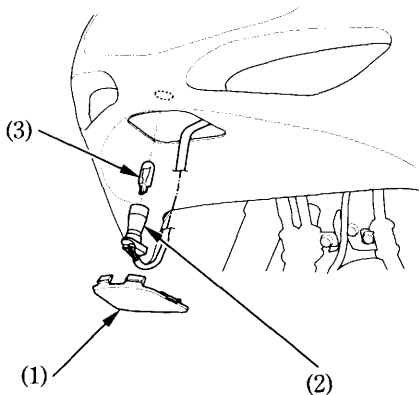

- (1) Position light cover
- (2) Position light reflector
- (3) Bulb

Stop/Tail Light Bulb

1. Remove the seat (page 54).
2. Turn the socket (1) 90° counter-clockwise, then pull it out toward you.
3. Pull out the bulb (2) without turning.
4. Install a new bulb in the reverse order of removal.

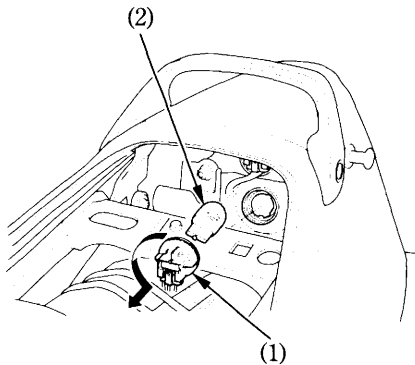

- (1) Socket
(2) Bulb

Front Turn Signal Bulb

1. Turn over the rearview mirror boot (1).
2. Remove the two mounting bolts (2) and the rearview mirror (3).
3. Turn the socket (4) 90° counterclockwise, and remove it.
4. Slightly press the bulb (5) and turn it counterclockwise.
5. Install a new bulb in the reverse order of removal.

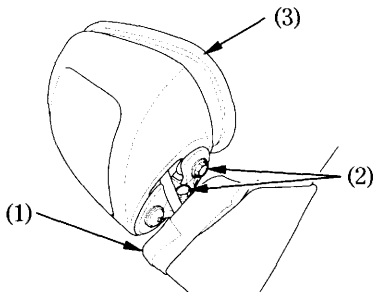
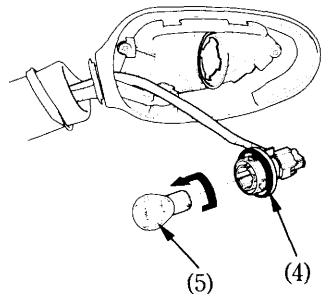
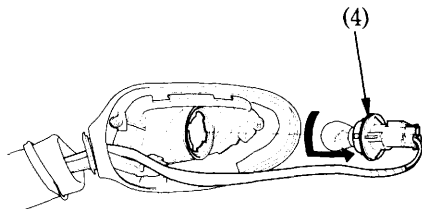

(1) Boot
(2) Bolts

(3) Rearview mirror

(4) Socket
(5) Bulb

Rear Turn Signal Bulb

1. Remove the rear turn signal lens (1) and the lens packing (2) by removing the screw (3).
2. Slightly press the bulb (4) and turn it counterclockwise.
3. Install a new bulb in the reverse order of removal.

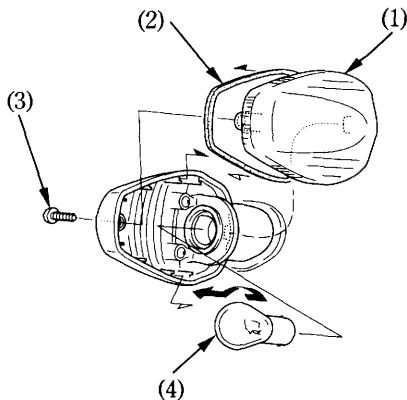

- (1) Lens
(2) Lens packing

- (3) Screw
(4) Bulb

CLEANING

Clean your motorcycle regularly to protect the surface finishes and inspect for damage, wear, and oil, coolant or brake fluid leakage.

Avoid cleaning products that are not specifically designed for motorcycle or automobile surfaces.

They may contain harsh detergents or chemical solvents that could damage the metal, paint, and plastic on your motorcycle.

If your motorcycle is still warm from recent operation, give the engine and exhaust system time to cool off.

We recommend avoiding the use of high pressure water spray (typical in coin-operated car washes).

NOTICE

High pressure water (or air) can damage certain parts of the motorcycle.

Do not apply the pressured water directly to the air intake (1). The water can be drawn into the throttle body and/or enter the air cleaner.

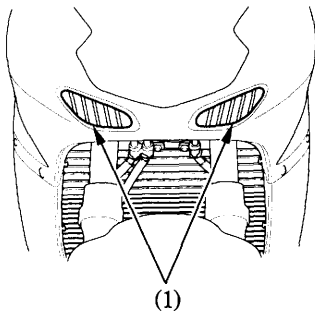

(1) Air intake

Washing the motorcycle

1. Rinse the motorcycle thoroughly with cool water to remove loose dirt.
2. Clean the motorcycle with a sponge or soft cloth using cool water.
Avoid directing water to muffler outlets and electrical parts.
3. Clean the fairing, headlight lens and other plastic parts using a cloth or sponge dampened with a solution of mild detergent and water. Rub the soiled area gently rinsing it frequently with fresh water.

The rear grab rail is also a plastic part and can be cleaned in the same manner as described above.

Take care to keep brake fluid or chemical solvents off the motorcycle.

They will damage the plastic and painted surfaces.

The inside of the headlight lens may be clouded immediately after washing the motorcycle. Moisture condensation inside the headlight lens will disappear gradually by lighting the headlight in high beam. Run the engine while keeping the headlight on.

4. After cleaning, rinse the motorcycle thoroughly with plenty of clean water. Strong detergent residue can corrode alloy parts.
5. Dry the motorcycle, start the engine, and let it run for several minutes.
6. Test the brakes before riding the motorcycle. Several applications may be necessary to restore normal braking performance.
7. Lubricate the drive chain immediately after washing and drying the motorcycle.

Braking efficiency may be temporarily impaired immediately after washing the motorcycle.

Anticipate longer stopping distance to avoid a possible accident.

Finishing Touches

After washing your motorcycle, consider using a commercially-available spray cleaner/polish or quality liquid or paste wax to finish the job. Use only a non-abrasive polish or wax made specifically for motorcycles or automobiles. Apply the polish or wax according to the instructions on the container.

If a surface on your motorcycle is chipped or scratched, your Honda dealer has touch-up paint to match your motorcycle's colour. Be sure to use your motorcycle's colour code (page 84) when you buy touch-up paint.

Removing Road Salt

The salt contained in the road surface freezing prevention medicine which a road was sprayed with in winter, and the seawater becomes the cause which rust occurs in.

Wash your motorcycle by the following point after it runs through such a place.

1. Clean the motorcycle using cool water (page 129).

Do not use warm water.

This worsens the effect of the salt.

2. Dry the motorcycle and the surface of the metal is protected with the wax.

Painted Aluminum Wheel Maintenance

Aluminum may corrode from contact with dirt, mud, or road salt. Clean the wheels after riding through any of these substances. Use a wet sponge and mild detergent. Avoid stiff brushes, steel wool, or cleaners containing abrasives or chemical compounds.

After washing, rinse with plenty of water and dry with a clean cloth.

Apply touch-up paint to the wheels where damage has resulted.

STORAGE GUIDE

Extended storage, such as for winter, requires that you take certain steps to reduce the effects of deterioration from non-use of the motorcycle. In addition, necessary repairs should be made BEFORE storing the motorcycle; otherwise, these repairs may be forgotten by the time the motorcycle is removed from storage.

STORAGE

1. Change the engine oil and filter.
2. Make sure the cooling system is filled with a 50/50 % antifreeze solution.
3. Empty the fuel tank into an approved petrol container using a commercially available hand siphon or an equivalent method. Spray the inside of the tank with an aerosol rust-inhibiting oil.

Reinstall the fuel fill cap on the tank.

WARNING

Petrol is highly flammable and explosive. You can be burned or seriously injured when handling fuel.

- Stop the engine and keep heat, sparks, and flame away.
- Refuel only outdoors.
- Wipe up spills immediately.

4. To prevent rusting in the cylinders, perform the following:
 - Remove the spark plug caps from the spark plugs. Using tape or string, secure the caps to any convenient plastic body part so that they are positioned away from the spark plugs.
 - Remove the spark plugs from the engine. Do not connect the spark plugs to the spark plug caps.
 - Pour a tablespoon (15–20 cm³) of clean engine oil into each cylinder and cover the spark plug holes with a piece of cloth.
 - Crank the engine several times to distribute the oil.
 - Reinstall the spark plugs and spark plug caps.
5. Remove the battery. Store in an area protected from freezing temperatures and direct sunlight.
Slow charge the battery once a month.
6. Wash and dry the motorcycle. Wax all painted surfaces. Coat chrome with rustinhibiting oil.
7. Lubricate the drive chain (page 104).
8. Inflate the tyres to their recommended pressures. Place the motorcycle on blocks to raise both tyres off the ground.
9. Cover the motorcycle (don't use plastic or other coated materials) and store in an unheated area, free of dampness with a minimum of daily temperature variation. Do not store the motorcycle in direct sunlight.

REMOVAL FROM STORAGE

1. Uncover and clean the motorcycle.

Change the engine oil if more than 4 months have passed since the start of storage.

2. Charge the battery as required. Install the battery.

3. Drain any excess aerosol rust-inhibiting oil from the fuel tank. Fill the fuel tank with fresh petrol.

4. Perform all Pre-ride Inspection checks (page 64).

Test ride the motorcycle at low speeds in a safe riding area away from traffic.

SPECIFICATIONS

DIMENSIONS

Overall length	2,160 mm (85.0 in)
Overall width	720 mm (28.3 in)
Overall height	1,200 mm (47.2 in)
Wheelbase	1,490 mm (58.7 in)

WEIGHT

Dry weight	223 kg (492 lbs) ... Except U, IIU type
	224 kg (494 lbs) ... U, IIU type

CAPACITIES

Engine oil	After draining	3.8 l (4.0 US qt , 3.3 Imp qt)
	After draining and oil filter change	3.9 l (4.1 US qt , 3.4 Imp qt)
	After disassembly	4.6 l (4.9 US qt , 4.0 Imp qt)
Fuel tank		23.0 l (6.08 US gal , 5.06 Imp gal)
Cooling system capacity		3.2 l (3.4 US qt , 2.8 Imp qt)
Passenger capacity		Operator and one passenger
Maximum weight capacity		185 kg (411 lbs)

ENGINE

Bore and stroke	79.0 × 58.0 mm (3.11 × 2.28 in)
Compression ratio	11.0 : 1
Displacement	1,137 cm ³ (69.4 cu-in)
Spark plug	IMR9C-9H (NGK)
Idle speed	1,100 ± 100 min ⁻¹ (rpm)
Valve clearance (Cold)	Intake 0.16 mm (0.006 in) Exhaust 0.22 mm (0.009 in)

CHASSIS AND SUSPENSION

Caster	25°
Trail	99 mm (3.9 in)
Tyre size, front	120/70 ZR17 M/C (58W)
Tyre size, rear	180/55 ZR17 M/C (73W)

POWER TRANSMISSION

Primary reduction	1.571
Gear ratio, 1st	2.769
2nd	2.000
3rd	1.579
4th	1.333
5th	1.167
6th	1.042
Final reduction	2.588

ELECTRICAL

Battery

12V – 10 AH

Generator

0.39kW/5,000 min⁻¹ (rpm) ... Except BR, U, IIU type

0.46kW/5,000 min⁻¹ (rpm) ... BR, U, IIU type

LIGHTS

Headlight

12V – 55W × 2

Stop/tail light

12V – 21/5W × 2

Turn signal light

Front

12V – 21W × 2

Rear

12V – 21W × 2

Instrument lights

14V – 1.4W × 2

Position light

12V – 5W ... Except U, IIU type

FUSE

Main fuse A

30A

FI fuse

30A

Other fuses

10A, 20A

CATALYTIC CONVERTERS

〈 Except BR type 〉

This motorcycle is equipped with catalytic converters.

Each catalytic converter contains precious metals that serve as catalysts, promoting chemical reactions to convert the exhaust gasses without affecting the metals.

The catalytic converters act on HC, CO, and NOx. Replacement parts must be original Honda parts or equivalents.

The catalytic converters must operate at a high temperature for the chemical reactions to take place. They can set on fire any combustible materials that come near them. Park your motorcycle away from high grasses, dry leaves, or other flammables.

Defective catalytic converters contribute to air pollution, and can impair your engine's performance. Follow these guidelines to protect your motorcycle's catalytic converters.

- Always use unleaded petrol. Even a small amount of leaded petrol can contaminate the catalyst metals, making the catalytic converters ineffective.
- Keep the engine tuned-up.
- Have your motorcycle diagnosed and replaced if it is misfiring, backfiring, stalling or otherwise not running properly.

NOISE CONTROL SYSTEM (AUSTRALIA ONLY)

TAMPERING WITH THE NOISE CONTROL SYSTEM IS PROHIBITED: Owners are warned that the law may prohibit : (a) The removal or rendering inoperative by any person other than for purposes of maintenance, repair, or replacement, of any device or element of design incorporated into any new vehicle for the purpose of noise control prior to its sale or delivery to the ultimate purchaser or while it is in use; and (b) the use of the vehicle after such device or element of design has been removed or rendered inoperative by any person.

CBR1100XX (BR)

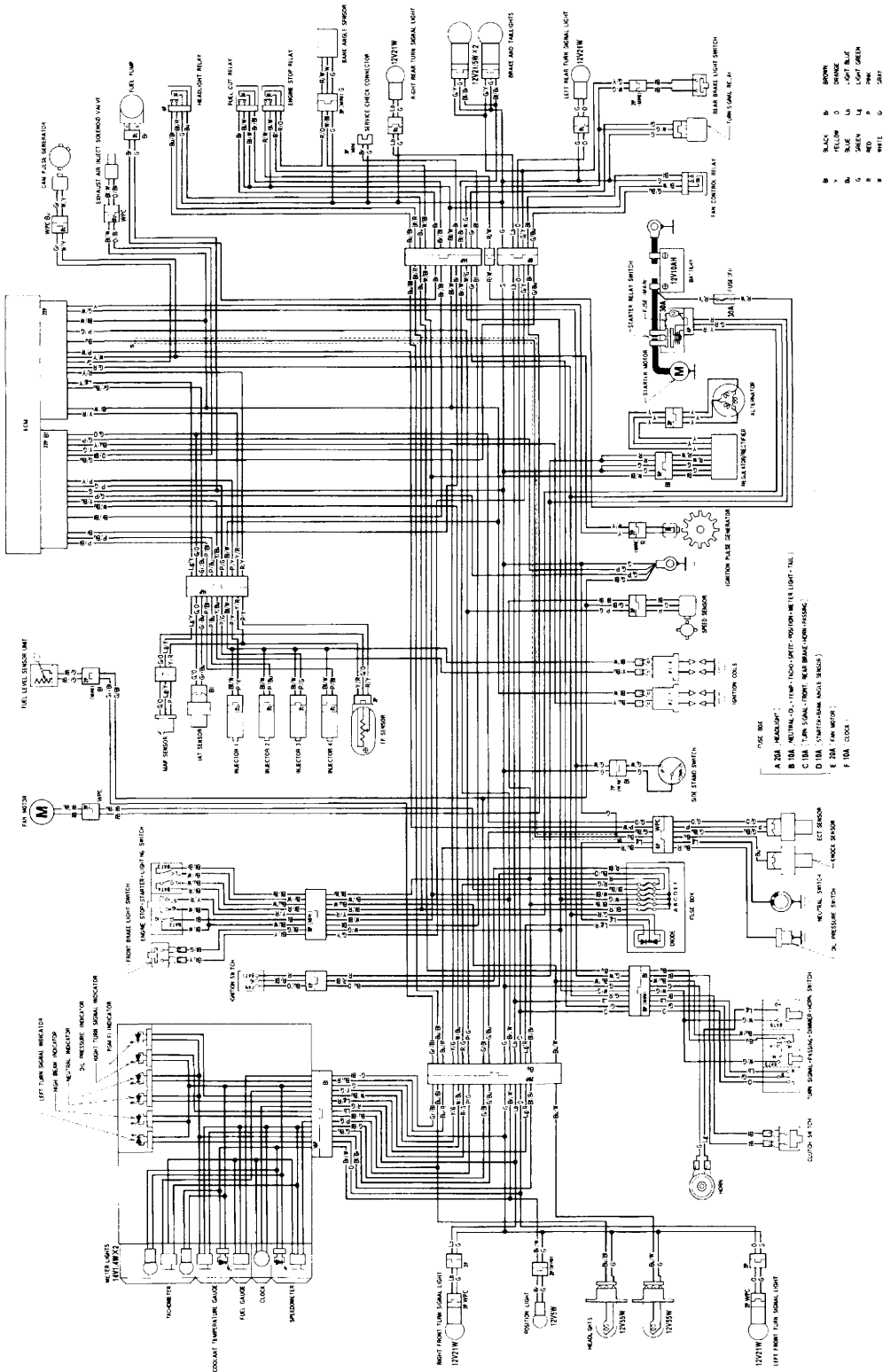

- BLACK
- BROWN
- YELLOW
- BLUE
- RED
- WHITE

- A RED - HEADLIGHT
- B BLUE - NEUTRAL LIGHT
- C BLACK - TURN SIGNAL (FRONT REAR BRAKE LIGHT)
- D GREEN - TURN SIGNAL (FRONT REAR BRAKE LIGHT)
- E YELLOW - FAN MOTOR
- F WHITE - CLOCK

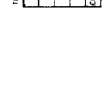
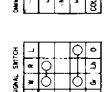
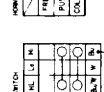
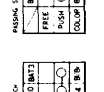
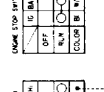
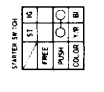
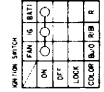

0030Z-MAT-B210

